

RESEARCH CENTRE

**Inria Centre at Université
Grenoble Alpes**

IN PARTNERSHIP WITH:

CNRS, Université de Grenoble Alpes

2024

ACTIVITY REPORT

Project-Team
TRIPOP

**Modeling, Simulation and Control of
Nonsmooth Dynamical Systems**

IN COLLABORATION WITH: Laboratoire Jean Kuntzmann (LJK)

DOMAIN

**Applied Mathematics, Computation and
Simulation**

THEME

**Optimization and control of dynamic
systems**

Inria

Contents

Project-Team TRIPOP	1
1 Team members, visitors, external collaborators	2
2 Overall objectives	3
2.1 Introduction	3
2.2 General scope and motivations	3
2.3 A flavor of nonsmooth dynamical systems	4
2.4 Nonsmooth Dynamical systems in the large	7
2.5 Nonsmooth systems versus hybrid systems	7
2.6 Numerical methods for nonsmooth dynamical systems	7
3 Research program	8
3.1 Introduction	8
3.2 Axis 1: Nonsmooth simulation and numerical modeling for natural gravitational risk in mountains.	8
3.2.1 Rockfall trajectory modeling	9
3.2.2 Modeling and simulation of gravity hazards (debris flows, avalanches and large-scale rock flows)	9
3.2.3 Data-driven modelling for prediction and mitigation of gravity hazards	10
3.3 Axis 2: Modeling, simulation and control of non-smooth dynamical systems.	10
3.3.1 Modeling, analysis and numerical methods	10
3.3.2 Automatic Control	12
4 Application domains	14
5 Social and environmental responsibility	14
6 New software, platforms, open data	14
6.1 New software	14
6.1.1 SICONOS	14
7 New results	18
7.1 Numerical Modeling for natural risk in mountains	18
7.1.1 Energy conservation and dissipation properties for elastodynamics with contact impact and friction	18
7.1.2 Numerical modeling of rockfall trajectory	18
7.1.3 Numerical modeling of fracture in solids	19
7.1.4 Variational approach for nonsmooth elasto-plastic dynamics with contact and impacts	19
7.1.5 Application of nonsmooth models of rockfall protection structures for the quantification of energy dissipation, warning and survey	19
7.2 Systemic risk	20
7.3 Numerical solvers for frictional contact problems.	20
7.4 Modeling of Impact Phenomena	21
7.5 Analysis and Control of Set-Valued Systems	21
7.5.1 Discrete-time implicit Euler sliding-mode control	21
7.5.2 Well-posedness of Time-Varying Linear Complementarity Systems	22
7.5.3 Multivalued Hamiltonian Systems in Discrete-Time	22
7.5.4 Emergent behaviors in nonlinear networks	22
7.5.5 Tracking control of Linear Complementarity Systems	22
7.5.6 Tracking control in frictional oscillators	22
8 Bilateral contracts and grants with industry	23
8.1 Bilateral grants with industry	23

9 Partnerships and cooperations	24
9.1 International research visitors	24
9.1.1 Visits of international scientists	24
9.2 European initiatives	24
9.2.1 Horizon Europe	24
9.3 National initiatives	25
9.3.1 Project SsONDS LabEx PERSIVAL ANR-15-IDEX-02 and ANR-11-LABX-0025-01	25
9.3.2 ANR SlimDisc	25
9.3.3 ANR SPECULAR	25
9.3.4 ANR MODEMSEA	26
9.3.5 PEPR Risques (Ex-IRIMA)	26
9.3.6 PEPR Math Vives - Mathematics for Life, Environment and Society	26
10 Dissemination	26
10.1 Promoting scientific activities	26
10.1.1 Scientific events: organisation	26
10.1.2 Journal	27
10.1.3 Invited talks	27
10.1.4 Leadership within the scientific community	28
10.1.5 Scientific expertise	28
10.1.6 Research administration	28
10.2 Teaching - Supervision - Juries	28
10.2.1 Teaching	28
10.2.2 Supervision	28
10.2.3 Juries	29
10.3 Popularization	29
11 Scientific production	29
11.1 Major publications	29
11.2 Publications of the year	30
11.3 Cited publications	32

Project-Team TRIPOP

Creation of the Project-Team: 2019 June 01

Keywords

Computer sciences and digital sciences

- A6.1.1. – Continuous Modeling (PDE, ODE)
- A6.1.4. – Multiscale modeling
- A6.2.6. – Optimization
- A6.4.1. – Deterministic control
- A6.4.3. – Observability and Controlability
- A6.4.4. – Stability and Stabilization
- A6.4.5. – Control of distributed parameter systems
- A6.4.6. – Optimal control
- A6.5.1. – Solid mechanics
- A6.5.4. – Waves

Other research topics and application domains

- B3.3.1. – Earth and subsoil
- B3.4.1. – Natural risks
- B5.2.1. – Road vehicles
- B5.2.3. – Aviation
- B5.2.4. – Aerospace
- B5.4. – Microelectronics
- B5.6. – Robotic systems
- B7.1.2. – Road traffic
- B9.5.2. – Mathematics
- B9.5.5. – Mechanics
- B9.11.1. – Environmental risks

1 Team members, visitors, external collaborators

Research Scientists

- Vincent Acary [Team leader, INRIA, Senior Researcher]
- Paul Armand [Inria secondment, UNIV LIMOGES, until Aug 2024, Professor, HDR]
- Franck Bourrier [INRAE, Senior Researcher]
- Bernard Brogliato [INRIA, Senior Researcher]
- Nicholas Anton Collins-Craft [INRIA, Starting Research Position, from Sep 2024 until Oct 2024]
- Olivier Goury [INRIA, Researcher]
- Felix Miranda Villatoro [INRIA, ISFP]
- Arnaud Tonnelier [INRIA, Researcher]

Post-Doctoral Fellows

- Nicholas Anton Collins-Craft [INRIA, Post-Doctoral Fellow, until Aug 2024]
- Antoine Cordoba [INRIA, Post-Doctoral Fellow, from Sep 2024]
- Ritesh Gupta [INRIA, Post-Doctoral Fellow, until Nov 2024]
- Simon Le Berre [INRIA, Post-Doctoral Fellow]

PhD Students

- Chloe Gergely [UGA, from Nov 2024]
- Louis Guillet [INRIA]
- Hoang Minh Nguyen [INRIA, until Sep 2024]
- Matteo Oziol [GRENOBLE INP]
- Quang Hung Pham [GRENOBLE INP]
- Florian Vincent [INRIA]
- Aya Younes [UGA, until Sep 2024]

Technical Staff

- Samuel Heidmann [INRIA, Engineer]
- Franck Pérignon [CNRS, Engineer]

Interns and Apprentices

- Anais Durin [INRIA, Intern, from Jun 2024 until Aug 2024]
- Raphael Gandin [ENS PARIS-SACLAY, Intern, from Jun 2024 until Jul 2024]
- Chloe Gergely [INRIA, Intern, from Apr 2024 until Sep 2024]

Administrative Assistant

- Diane Courtiol [INRIA]

Visiting Scientists

- Paul Armand [UNIV LIMOGES, from Sep 2024, HDR]
- Fernando Castanos Luna [IPN MEXICO, until Jan 2024]

2 Overall objectives

2.1 Introduction

The joint research team, TRIPOP, between INRIA Grenoble Rhône-Alpes, Grenoble INP and CNRS, part of the Laboratoire Jean Kuntzmann (LJK UMR 5224) is mainly concerned with the modeling, the mathematical analysis, the simulation and the control of nonsmooth dynamical systems, with a strong application to modeling natural environmental risks in mountains.

Nonsmooth dynamics concerns the study of the time evolution of systems that are not smooth in the mathematical sense, *i.e.* systems that are characterized by a lack of differentiability, either of the mappings in their formulations, or of their solutions with respect to time. In mechanics, the main instances of nonsmooth dynamical systems are multibody systems with Signorini unilateral contact, set-valued (Coulomb-like) friction and impacts. In electronics, examples are found in switched electrical circuits with ideal components (diodes, switches, transistors). In control, nonsmooth systems arise in the sliding mode control theory and in optimal control. Many examples can also be found in cyber-physical systems (hybrid systems), in transportation sciences, in mathematical biology or in finance. For the next four years, the team is organized along two research axes: 1) nonsmooth simulation and numerical modeling for natural gravitational risks in mountains and 2) modeling, simulation and control of nonsmooth dynamical systems. The idea of this restructuring is to put forward a strong application axis for which there is a strong academic research dynamic in the Grenoble region and a network of socio-economic actors very interested in an industrial transfer of digital science methods on these subjects. The second axis takes up the main themes of the former axes of the TRIPOP project by updating them after the first four years.

2.2 General scope and motivations

Nonsmooth dynamics concerns the study of the time evolution of systems that are not smooth in the mathematical sense, *i.e.*, systems that are characterized by a lack of differentiability, either of the mappings in their formulations, or of their solutions with respect to time. The class of nonsmooth dynamical systems recovers a large variety of dynamical systems that arise in many applications. The term “nonsmooth”, like the term “nonlinear”, does not precisely define the scope of the systems we are interested in but, and most importantly, they are characterized by the mathematical and numerical properties that they share. To give more insight into nonsmooth dynamical systems, we give in the following a very brief introduction of their salient features. For more details, we refer to [64, 30][2][78, 48, 67].

As we have indicated there are many applications to the methods of nonsmooth dynamics. We have chosen a strong particular application for this technique of nonsmooth dynamics which is that of natural gravity risk in the mountains. The choice of this application is particularly motivated by global climate change which has increased the number of rockfall and landslide events very significantly in recent decades. Especially, the effects of melting permafrost, increased rainfall and rapid temperature changes means that alpine regions are particularly at risk [89, 77]. Another important interest is the strong academic research dynamics in the Grenoble region and a network of socio-economic actors very interested in an industrial transfer of digital science methods on these subjects. The team will conduct research on the mechanical modeling and simulation of natural hazards in mountains (floods and debris flows, block falls, glacial hazards), bringing new software development in a high performance computing (HPC) framework.

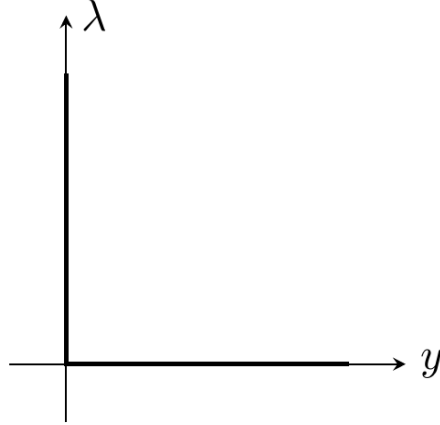

Figure 1: Complementarity condition $0 \leq \gamma \perp \lambda \geq 0$.

2.3 A flavor of nonsmooth dynamical systems

As a first illustration, let us consider a linear finite-dimensional system described by its state $x(t) \in \mathbb{R}^n$ over a time-interval $t \in [0, T]$:

$$\dot{x}(t) = Ax(t) + a, \quad A \in \mathbb{R}^{n \times n}, a \in \mathbb{R}^n, \quad (1)$$

subjected to a set of m inequality (unilateral) constraints:

$$y(t) = Cx(t) + c \geq 0, \quad C \in \mathbb{R}^{m \times n}, c \in \mathbb{R}^m. \quad (2)$$

If the constraints are physical constraints, a standard modeling approach is to augment the dynamics in (1) by an input vector $\lambda(t) \in \mathbb{R}^m$ that plays the role of a Lagrange multiplier vector. The multiplier restricts the trajectory of the system in order to respect the constraints. Furthermore, as in the continuous optimization theory, the multiplier must be signed and must vanish if the constraint is not active. This is usually formulated as a complementarity condition:

$$0 \leq y(t) \perp \lambda(t) \geq 0, \quad (3)$$

which models the one-sided effect of the inequality constraints. The notation $y \geq 0$ holds component-wise and $y \perp \lambda$ means $y^T \lambda = 0$. All together we end up with a Linear Complementarity System (LCS) of the form,

$$\begin{cases} \dot{x}(t) = Ax(t) + a + B\lambda(t) \\ y(t) = Cx(t) + c \\ 0 \leq y(t) \perp \lambda(t) \geq 0 \end{cases} \quad (4)$$

where $B \in \mathbb{R}^{n \times m}$ is the matrix that models the input generated by the constraints. In a more general way, the constraints may also involve the Lagrange multiplier,

$$y(t) = Cx(t) + c + D\lambda(t) \geq 0, \quad D \in \mathbb{R}^{m \times m}, \quad (5)$$

leading to a general definition of LCS as

$$\begin{cases} \dot{x}(t) = Ax(t) + a + B\lambda(t) \\ y(t) = Cx(t) + c + D\lambda(t) \\ 0 \leq y(t) \perp \lambda(t) \geq 0. \end{cases} \quad (6)$$

The complementarity condition, illustrated in Figure 1 is the archetype of a nonsmooth graph that we extensively use in nonsmooth dynamics. The mapping $y \mapsto \lambda$ is a multi-valued (set-valued) mapping, that is nonsmooth at the origin. It has many interesting mathematical properties and reformulations

that come mainly from convex analysis and variational inequality theory. Let us introduce the indicator function of \mathbb{R}_+ as

$$\Psi_{\mathbb{R}_+}(x) = \begin{cases} 0 & \text{if } x \geq 0, \\ +\infty & \text{if } x < 0. \end{cases} \quad (7)$$

This function is convex, proper and can be sub-differentiated [71]. The definition of the subdifferential of a convex function $f: \mathbb{R}^m \rightarrow \mathbb{R}$ is defined as:

$$\partial f(x) = \{x^* \in \mathbb{R}^m \mid f(z) \geq f(x) + (z-x)^\top x^*, \forall z\}. \quad (8)$$

A basic result of convex analysis is

$$0 \leq y \perp \lambda \geq 0 \iff -\lambda \in \partial \Psi_{\mathbb{R}_+}(y) \quad (9)$$

that gives a first functional meaning to the set-valued mapping $y \mapsto \lambda$. Another interpretation of $\partial \Psi_{\mathbb{R}_+}$ is based on the normal cone to a closed and nonempty convex set C :

$$N_C(x) = \{v \in \mathbb{R}^m \mid v^\top (z-x) \leq 0 \text{ for all } z \in C\}. \quad (10)$$

It is easy to check that $\partial \Psi_{\mathbb{R}_+}(x) = N_{\mathbb{R}_+}(x)$ and it follows that

$$0 \leq y \perp \lambda \geq 0 \iff -\lambda \in N_{\mathbb{R}_+}(y). \quad (11)$$

Finally, the definition of the normal cone yields a variational inequality:

$$0 \leq y \perp \lambda \geq 0 \iff \lambda^\top (y-z) \leq 0, \forall z \geq 0. \quad (12)$$

The relations (11) and (12) allow one to formulate the complementarity system with $D = 0$ as a differential inclusion based on a normal cone (see (15)) or as a differential variational inequality. By extending the definition to other types of convex functions, possibly nonsmooth, and using more general variational inequalities, the same framework applies to the nonsmooth laws depicted in Figure 2 that includes the case of piecewise smooth systems.

The mathematical concept of solutions depends strongly on the nature of the matrix quadruplet (A, B, C, D) in (6). If D is a positive definite matrix (or a P -matrix), the Linear Complementarity problem

$$0 \leq Cx + c + D\lambda \perp \lambda \geq 0, \quad (13)$$

admits a unique solution $\lambda(x)$ which is a Lipschitz continuous mapping. It follows that the Ordinary Differential Equation (ODE)

$$\dot{x}(t) = Ax(t) + a + B\lambda(x(t)), \quad (14)$$

is a standard ODE with a Lipschitz right-hand side with a C^1 solution for the initial value problem. If $D = 0$, the system can be written as a differential inclusion in a normal cone as

$$-\dot{x}(t) + Ax(t) + a \in BN_{\mathbb{R}_+}(Cx(t)), \quad (15)$$

that admits a solution that is absolutely continuous if CB is a definite positive matrix and the initial condition satisfies the constraints. The time derivative $\dot{x}(t)$ and the multiplier $\lambda(t)$ may have jumps and are generally considered as functions of bounded variations. If $CB = 0$, the order of nonsmoothness increases and the Lagrange multiplier may contain Dirac atoms and must be considered as a measure. Higher-order index, or higher relative degree systems yield solutions in terms of distributions and derivatives of distributions [42].

A lot of variants can be derived from the basic form of linear complementarity systems, by changing the form of the dynamics including nonlinear terms or by changing the complementarity relation by other multivalued maps. In particular the nonnegative orthant may be replaced by any convex closed cone $K \subset \mathbb{R}^m$ leading to complementarity over cones

$$K^* \ni y \perp \lambda \in K, \quad (16)$$

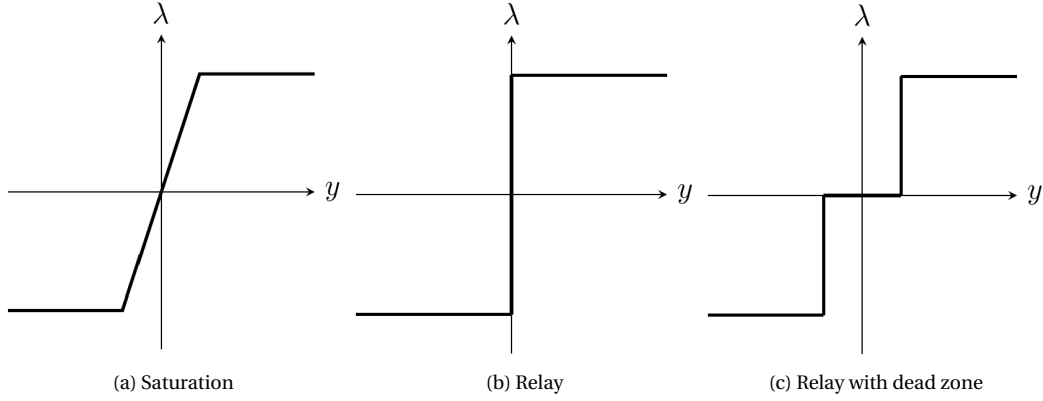

Figure 2: Examples of multivalued piecewise linear models

where K^* its dual cone given by

$$K^* = \{x \in \mathbb{R}^m \mid x^\top y \geq 0 \text{ for all } y \in K\}. \quad (17)$$

In Figure 2, we illustrate some other basic maps that can be used for defining the relation between λ and y . The saturation map, depicted in Figure 2(a) is a single valued continuous function which is an archetype of a piece-wise smooth map. In Figure 2(b), the relay multi-function is illustrated. If the upper and the lower limits of λ are respectively equal to 1 and -1 , we obtain the multivalued sign function defined as

$$\text{Sgn}(y) = \begin{cases} 1, & y > 0 \\ [-1, 1], & y = 0 \\ -1, & y < 0. \end{cases} \quad (18)$$

Using again convex analysis, the multivalued sign function may be formulated as an inclusion into a normal cone as

$$\lambda \in \text{Sgn}(y) \iff y \in N_{[-1,1]}(\lambda). \quad (19)$$

More generally, any system of the type,

$$\begin{cases} \dot{x}(t) = Ax(t) + a + B\lambda(t) \\ y(t) = Cx(t) + a \\ -\lambda(t) \in \text{Sgn}(y(t)), \end{cases} \quad (20)$$

can reformulated in terms of the following set-valued system

$$\begin{cases} \dot{x}(t) = Ax(t) + a + B\lambda(t) \\ y(t) = Cx(t) + c \\ -y(t) \in N_{[-1,1]^m}(\lambda(t)). \end{cases} \quad (21)$$

The system (21) appears in a lot of applications; among them, we can cite the sliding mode control, electrical circuits with relay and Zener diodes [37], or mechanical systems with friction [30].

Though this class of systems seems to be rather specific, it includes as well more general dynamical systems such as piecewise smooth systems and discontinuous ordinary differential equations. Indeed, the system (20) for scalars y and λ can be viewed as a discontinuous differential equation:

$$\dot{x}(t) = \begin{cases} Ax + a + B & \text{if } Cx + c > 0 \\ Ax + a - B & \text{if } Cx + c < 0. \end{cases} \quad (22)$$

One of the most well-known mathematical frameworks to deal with such systems is the Filippov theory [64] that embeds the discontinuous differential equations into a differential inclusion. In the case of a

single discontinuity surface given in our example by $S = \{x \mid Cx + c = 0\}$, the Filippov differential inclusion based on the convex hull of the vector fields in the neighborhood of S is equivalent to the use of the multivalued sign function in (20). Conversely, as it has been shown in [44], a piecewise smooth system can be formulated as a nonsmooth system based on products of multivalued sign functions.

2.4 Nonsmooth Dynamical systems in the large

Generally, the nonsmooth dynamical systems we propose to study mainly concern systems that possess the following features:

- (i) A nonsmooth formulation of the constitutive/behavioral laws that define the system. Examples of nonsmooth formulations are piecewise smooth functions, multi-valued functions, inequality constraints, yielding various definitions of dynamical systems such as piecewise smooth systems, discontinuous ordinary differential equations, complementarity systems, projected dynamical systems, evolution or differential variational inequalities and differential inclusions (into normal cones). Fundamental mathematical tools come from convex analysis [90, 70, 71], complementarity theory [60], and variational inequalities theory [63].
- (ii) A concept of solutions that does not require continuously differentiable functions of time. For instance, absolutely continuous, Lipschitz continuous functions or functions of local bounded variation are the basis for solution concepts. Measures or distributions are also solutions of interest for differential inclusions or evolution variational inequalities.

2.5 Nonsmooth systems versus hybrid systems

The nonsmooth dynamical systems we are dealing with, have a nonempty intersection with hybrid systems and cyber-physical systems, as is briefly discussed in Sect. 3.3.1. Like in hybrid systems, nonsmooth dynamical systems define continuous-time dynamics that can be identified with modes separated by guards, defined by the constraints. However, the strong mathematical structure of nonsmooth dynamical systems allows us to state results on the following points:

- (i) Mathematical concept of solutions: well-posedness (existence, and possibly, uniqueness properties, (dis)continuous dependence on initial conditions).
- (ii) Dynamical systems theoretic properties: existence of invariants (equilibria, limit cycles, periodic solutions, . . .) and their stability, existence of oscillations, periodic and quasi-periodic solutions and propagation of waves.
- (iii) Control theoretic properties: passivity, controllability, observability, stabilization, robustness.

These latter properties, that are common for smooth nonlinear dynamical systems, distinguish the nonsmooth dynamical systems from the very general definition of hybrid or cyber-physical systems [46, 69]. Indeed, it is difficult to give a precise mathematical concept of solutions for hybrid systems since the general definition of hybrid automata is usually too loose.

2.6 Numerical methods for nonsmooth dynamical systems

To conclude this brief exposition of nonsmooth dynamical systems, let us recall an important fact related to numerical methods. Beyond their intrinsic mathematical interest, and the fact that they model real physical systems, using nonsmooth dynamical systems as a model is interesting, because there exists a large set of robust and efficient numerical techniques to simulate them. Without entering into the finer details, let us give two examples of these techniques:

- *Numerical time integration methods: convergence, efficiency (order of consistency, stability, symplectic properties).* For the nonsmooth dynamical systems described above, there exist event-capturing time-stepping schemes with strong mathematical results. These schemes have the ability to numerically integrate the initial value problem without performing an event location, but by capturing the event within a time step. We call an event, or a transition, every change into the index

set of the active constraints in the complementarity formulation or in the normal cone inclusion. Hence these schemes are able to simulate systems with a huge number of transitions or even with finite accumulation of events (Zeno behavior). Furthermore, the schemes do not suffer from the weaknesses of the standard schemes based on a regularization (smoothing) of the multi-valued mapping resulting in stiff ordinary differential equations. For the time-integration of the initial value problem (IVP), or Cauchy problem, a lot of improvements of the standard time-stepping schemes for nonsmooth dynamics (Moreau–Jean time-stepping scheme) have been proposed in the last decade, in terms of accuracy and dissipation properties [34, 35, 91, 92, 33, 58, 54, 94, 56]. A significant number of these schemes have been developed by members of the BIPOP team and have been implemented in the Siconos software.

- *Numerical solution procedure for the time-discretized problem, mainly through well-identified problems studied in the optimization and mathematical programming community.* Another very interesting feature is the fact that the discretized problem that we have to solve at each time-step is generally a well-known problem in optimization. For instance, for LCSs, we have to solve a linear complementarity problem [60] for which there exist efficient solvers in the literature. Compared to the brute force algorithm with exponential complexity that consists of enumerating all the possible modes, the algorithms for linear complementarity problem have polynomial complexity when the problem is monotone.

3 Research program

3.1 Introduction

In this section, we develop our scientific program. In the framework of nonsmooth dynamical systems, the activities of the project-team will be focused on the following research axes:

- **Axis 1:** Nonsmooth simulation and numerical modeling for natural gravitational risk in mountains. (detailed in Sect. 3.2).
- **Axis 2:** Modeling, simulation and control (detailed in Sect. 3.3).

These research axes will be developed with a strong emphasis on the software development and the industrial transfer.

3.2 Axis 1: Nonsmooth simulation and numerical modeling for natural gravitational risk in mountains.

In this research axis, we propose, on the one hand, to extend existing methods of simulation in mechanics of complex flows in a nonsmooth framework, which allows us to simplify the models by decreasing the physical parameters, and to make more robust the numerical simulations and thus to make possible the construction of reduced models or meta-models. On the other hand, the so-called "data-driven modeling" methods will be explored for gravity flows and prevention structures. The aim is to make the most of laboratory and observational data in order to build and calibrate the models, to evaluate their sensitivity, to improve their predictive character, *i.e.* to control and take into account the uncertainties, thanks to variational, statistical and AI methods.

This work will be conducted in close collaboration with the UR IGE of INRAE as well as other researchers from INRIA (AIRSEA, LEMON). More generally, our collaboration with INRAE opens new long term perspectives on granular flow applications such as debris and mud flows, granular avalanches and the design of structural protections. The numerical methods that go with these new modeling approaches will be implemented in our software Siconos).

This research is also part of the more general context of a digital platform on environmental risk in the mountains, including intensive and cloud computing.

3.2.1 Rockfall trajectory modeling

Trajectory analysis of falling rocks during rockfall events is limited by the currently unrefined modeling of the impact phase [51, 50, 79]. The goal of this axis is to improve reliability of simulation techniques.

- *Rock fracturing*: When a rock falls from a steep cliff, it stores a large amount of kinetic energy that is partly dissipated through the impact with the ground. If the ground is composed of rocks and the kinetic energy is sufficiently high, the probability of the fracture of the rock is high and yields an extra amount of dissipated energy but also an increase of the number of blocks that fall. In this topic, we want to use the capability of the nonsmooth dynamical framework for modeling cohesion and fracture [76, 32] to propose new cohesive zone models with contact and friction.
- *Rock/forest interaction*: To prevent damage and incidents to infrastructure, a smart use of the forest is one of the ways to control trajectories (decrease of the run-out distance, jump heights and the energy) of the rocks that fall under gravity [61, 62]. From the modeling point of view and to be able to improve the protective function of the forest, an accurate modeling of impacts between rocks and trees is required. Due to the aspect ratio of the trees, they must be considered as flexible bodies that may be damaged by the impact. This new aspect offers interesting modeling research perspectives, especially, building rockfall simulation method with mechanical models of trees including damage, fracture and plasticity.
- *Experimental validation*: The participation of INRAE with F. Bourrier makes possible the experimental validation of models and simulations through comparisons with real data. INRAE has extensive experience of lab and in-situ experiments for rockfall trajectory modeling [51, 50]. It is a unique opportunity to strengthen our model and to prove that nonsmooth modeling of impacts is reliable for such experiments and forecasting of natural hazards.

3.2.2 Modeling and simulation of gravity hazards (debris flows, avalanches and large-scale rock flows)

Different modeling approaches are used in the literature depending on the type of hazard.

For rockfalls and dense snow avalanches, methods that explicitly model the particles of granular materials (notably Discrete Element Methods - DEM) are preferred, whereas for flows (debris flows, avalanches and large-scale rockfalls), methods that assimilate the large number of individual constituents to materials with complex rheology are more commonly used (notably Material Point Method - MPM, Smoothed-Particle Hydrodynamics - SPH, Shallow Water models - SWM). It should be noted that these methods are most often explicit and regularize the constraints of inequalities and thresholds.

This research item will develop the following points:

- *Rethinking DEM, MPM, SPH and SWM methods in the nonsmooth framework*. This will allow a simple and efficient modeling of threshold and inequality phenomena (one-sided contact, impact with Coulomb friction, threshold behavior laws such as plasticity, damage or fracture, Bingham-type fluids) in order to develop new, implicit and robust numerical methods, where the most important physical features of frictional cohesive materials are well-modeled neglecting the second order phenomena. In a context of data utilization and prediction, these methods seem particularly well suited as our first experiments on block trajectory and rock flows have already shown.
- *Couple these methods to integrate the "multi-scale (micro/meso/macro)" character* of these problems or, more simply, to spatially couple at the same scale several physical phenomena better taken into account by different methods, for example a debris flow containing a material with complex rheology (MPM or SPH) and large size particles (DEM)
- *Use "data-driven mechanics" approaches* when behavioral models are not reliable and faithful to the observed physical phenomena. These techniques can also be used to model "sub-mesh" phenomena, which are not or only slightly taken into account in large-scale phenomenological models.

3.2.3 Data-driven modelling for prediction and mitigation of gravity hazards

The objective is to develop simplified models that can be used extensively for the development of calibration and uncertainty quantification methods that allow for the joint use of data from various sources to evaluate and improve the predictive capacity of gravity hazard models.

The following points will be developed:

- *Statistical models* integrating various types of data and the hazard models developed in the previous section. The identification of the parameters of these hazard models, in particular using Bayesian approaches, will also allow the calibration and quantification of the uncertainties associated with the hazard models.
- *Model reduction approaches* (POD, PGD,...) or construction of substitution models (Sparse Polynomial Chaos, Gaussian Processes,...) to build simplified models usable in this context.
- *Application of different data assimilation techniques* (particle filters or variational methods) on the models described in the first axis and the reduced order models.

3.3 Axis 2: Modeling, simulation and control of non-smooth dynamical systems.

This axis is dedicated to the modeling and the mathematical analysis of nonsmooth dynamical systems. It consists of two main directions: 1) Modeling, analysis and numerical methods and 2) Automatic control.

3.3.1 Modeling, analysis and numerical methods

Multibody vibro-impact systems

- *Multiple impacts with or without friction (short-term)*: there are many different approaches to model collisions, especially simultaneous impacts (so-called multiple impacts)[87]. One of our objectives is on one hand to determine the range of application of the models (for instance, when can one use “simplified” rigid contact models relying on kinematic, kinetic or energetic coefficients of restitution?) on typical benchmark examples (chains of aligned beads, rocking block systems). On the other hand, we will try to take advantage of the new results on nonlinear wave phenomena, to better understand multiple impacts in 2D and 3D granular systems. The study of multiple impacts with (unilateral) nonlinear visco-elastic models (Simon–Hunt–Crossley, Kuwabara–Kono), or visco-elasto-plastic models (assemblies of springs, dashpots and dry friction elements), is also a topic of interest, since these models are widely used.
- *Artificial or manufactured or ordered granular crystals, meta-materials (short-term)*: Granular metamaterials (or more general nonlinear mechanical metamaterials) offer many perspectives for the passive control of waves originating from impacts or vibrations. The analysis of waves in such systems is delicate due to spatial discreteness, nonlinearity and non-smoothness of contact laws [88, 74, 75, 80]. We will use a variety of approaches, both theoretical (e.g. bifurcation theory, modulation equations) and numerical, in order to describe nonlinear waves in such systems, with special emphasis on energy localization phenomena (excitation of solitary waves, fronts, breathers).
- *Systems with clearances, modeling of friction (long-term)*: joint clearances in kinematic chains deserve specific analysis, especially concerning friction modeling[45]. Indeed contacts in joints are often conformal, which involve large contact surfaces between bodies. Lubrication models should also be investigated.
- *Painlevé paradoxes (long-term)*: the goal is to extend the results in [66], which deal with single-contact systems, to multi-contact systems. One central difficulty here is the understanding and the analysis of singularities that may occur in sliding regimes of motion.

As a continuation of the work in the BIPOP team, our software Siconos will be our favored software platform for the integration of these new modeling results.

Systemic risk

- The high consumption of natural resources by our society puts in question its long-term sustainability. The decrease of natural resources results in a deterioration of human welfare with a risk of society instability. Recently, a simple nature-society interrelations model, called the HANDY model (Human And Nature DYnamics), has been proposed by Montesharrei *et al* (2014) to address this concern with a special emphasis on the role of the stratification of the society. The Handy model is a four dimensional nonlinear dynamical system that describes the evolution of population, resources and accumulated wealth. We analyse the dynamics of this model and we explore the influence of two parameters: the nature depletion rate and the inequality factor. We characterize the asymptotic states of the system through a bifurcation analysis and we derive several quantitative results on the trajectories. We show that some collapses are irreversible and, depending on the wealth production factor, a bistability regime between a sustainable equilibrium and cycles of *collapse-and-regeneration* can be obtained. We discuss possible policies to avoid dramatic scenarios.

Cyber-physical systems (hybrid systems) Participants: V. Acary, B. Brogliato, C. Prieur, A. Tonnelier

Nonsmooth systems have a non-empty intersection with hybrid systems and cyber-physical systems. However, nonsmooth systems enjoy strong mathematical properties (concept of solutions, existence and uniqueness) and efficient numerical tools. This is often the result of the fact that nonsmooth dynamical systems are models of physical systems, and so can take advantage of their intrinsic properties (conservation or dissipation of energy, passivity, stability). A standard example is a circuit with n ideal diodes. From the hybrid point of view, this circuit is a piecewise smooth dynamical system with 2^n modes, that can be quite cumbersome to enumerate in order to determinate the current mode. As a nonsmooth system, this circuit can be formulated as a complementarity system for which there exist efficient time-stepping schemes and polynomial time algorithms for the computation of the current mode. The key idea of this research action is to benefit from this observation to improve hybrid system modeling tools.

- *Structural analysis of multimode DAE* : When a hybrid system is described by a Differential Algebraic Equation (DAE) with different differential indices in each continuous mode, the structural analysis has to be completely rethought. In particular, the re-initialization rule, when a switching occurs from one mode to another, has to be consistently designed. We propose in this action to use our knowledge in complementarity and (distribution) differential inclusions [42] to design consistent re-initialization rules for systems with nonuniform relative degree vector (r_1, r_2, \dots, r_m) and $r_i \neq r_j, i \neq j$.

- *Cyber-physical in hybrid systems modeling languages* : Nowadays, some hybrid modeling languages and tools are widely used to describe and to simulate hybrid systems (MODELICA, SIMULINK, and see [57] for references therein). Nevertheless, the compilers and the simulation engines behind these languages and tools suffer from several serious weaknesses (failure, nonsensical output or extreme sensitivity to simulation parameters), especially when some components, that are standard in nonsmooth dynamics, are introduced (piecewise smooth characteristic, unilateral constraints and complementarity condition, relay characteristic, saturation, dead zone, ...). One of the main reasons is the fact that most of the compilers reduce the hybrid system to a set of smooth modes modeled by differential algebraic equations and some guards and reinitialization rules between these modes. Sliding mode and Zeno-type behaviour are extremely difficult for hybrid systems and relatively simple for nonsmooth systems. With B. Caillaud (Inria HYCOMES) and M. Pouzet (Inria PARKAS), we propose to improve this situation by implementing a module able to identify/describe nonsmooth elements and to efficiently handle them with SICONOS as the simulation engine. They have already carried out a first implementation [55] in Zelus, a synchronous language for hybrid systems *Zelus*. Removing the weaknesses related to the nonsmoothness of solutions should improve hybrid systems towards robustness and certification.

- *A general solver for piecewise smooth systems* This direction is the continuation of the promising result on modeling and the simulation of piecewise smooth systems [44]. As for general hybrid automata, the notion or concept of solutions is not rigorously defined from the mathematical point of view. For piecewise smooth systems, multiplicity of solutions can happen and sliding solutions are common. The objective is to recast general piecewise smooth systems in the framework of differential inclusions with Aizerman-Pyatnitskii extension [44, 64]. This operation provides a precise meaning to

the concept of solutions. Starting from this point, the goal is to design and study an efficient numerical solver (time-integration scheme and optimization solver) based on an equivalent formulation as mixed complementarity systems of differential variational inequalities. We are currently discussing the issues in the mathematical analysis. The goal is to prove the convergence of the time-stepping scheme to get an existence theorem. With this work, we should also be able to discuss the general Lyapunov stability of stationary points of piecewise smooth systems.

Numerical optimization for discrete nonsmooth problems

- **Second Order Cone Complementarity Problems (SOCCP)** for discrete frictional systems (short-term): After some extensive comparisons of existing solvers on a large collection of examples [29, 39], the numerical treatment of constraint redundancy by the proximal point technique and the augmented Lagrangian formulation seems to be a promising path for designing new methods. From the comparison results, it appears that the redundancy of constraints prevents the use of second order methods such as semi-smooth Newton methods or interior point methods. With P. Armand (XLIM, U. de Limoges), we propose to adapt recent advances for regularizing constraints for the quadratic problem [65] for the second-order cone complementarity problem.
- The other question is the improvement of the efficiency of the algorithms by using accelerated schemes for the proximal gradient method that come from large-scale machine learning and image processing problems. Learning from the experience in large-scale machine learning and image processing problems, the accelerated version of the classical gradient algorithm [84] and the proximal point algorithm [47], and many of their further extensions, could be of interest for solving discrete frictional contact problems. Following the visit of Y. Kanno (University of Tokyo) and his preliminary experience on frictionless problems, we will extend its use to frictional contact problem. When we face large-scale problems, the main available solvers is based on a Gauss–Seidel strategy that is intrinsically sequential. Accelerated first-order methods could be a good alternative to benefit from distributed scientific computing architectures.

3.3.2 Automatic Control

This last item is dedicated to the automatic control of nonsmooth dynamical systems, or the nonsmooth control of smooth systems. The first research direction concerns the discrete-time sliding mode control and differentiation. The second research direction concerns multibody systems with unilateral constraint, impacts and set-valued friction. The third research direction concerns a class of dynamics which is an extension of linear complementarity systems (or, equivalently, of differential algebraic equations).

Discrete-time Sliding-Mode Control (SMC), State Observers (SMSO) and Differentiators (SMD)

- *SMC with output feedback*: Output feedback can take different forms, like the use of observers/differentiators in the loop (specific dynamic output feedback), or the design of static or dynamic output feedback (without state observation). The time-discretization of such feedback systems and its analysis remains largely open.
- *Unifying algorithm for discrete-time SMC and SMD*: maximal monotone operators, proximal algorithms.

Control of nonsmooth discrete Lagrangian systems

- *Linear Complementarity Systems (LCS)*: the PhD thesis of Aya Younes is dedicated to the trajectory tracking control in LCS. In particular the cases with uncertainties and with state jumps are carefully analysed. The PhD thesis of Quang-Hung Pham focuses on networks of LCS. In both cases passivity is a central tool for the analysis.
- *Optimal control*: the optimal control of mechanical systems with unilateral constraints and impacts, largely remains an open issue. Through a collaboration with Moritz Diehl (Freiburg University) the problem has been tackled using a suitable dynamics transformation of Lagrangian complementarity

systems into a Filippov "classical" differential inclusion with absolutely continuous solutions. The results are restricted to a single unilateral frictionless constraint. The global objective is to enlarge it to multiple unilateral constraints (hence multiple impacts) and friction.

- *Cable-driven systems*: these systems are typically different from the cable-car systems, and are closer in their mechanical structure to so-called tensegrity structures. The objective is to actuate a system *via* cables supposed in the first instance to be flexible (slack mode) but non-extensible in their longitudinal direction. This gives rise to complementarity conditions, one big difference with usual complementarity Lagrangian systems being that the control actions operate directly in one of the complementary variables (and not in the smooth dynamics as in cable-car systems). Therefore both the cable models and the control properties are expected to differ a lot from what we may use for cableway systems (for which guaranteeing a positive cable tension is usually not an issue, hence avoiding slack modes, but the deformation of the cables due to the nacelles and cables weights, is an important factor). Tethered systems are a close topic.
- *Robot-object underactuated dynamical systems*: such systems are made of a controlled part (called the robot) and an uncontrolled part (called the object). Both are linked by Lagrange multipliers which represent the contact forces. The object can be controlled only through the multipliers, which are in turn a function of the system's state. Examples are bipeds which walk, run, jump, juggling, tapping, pushing robots, prehensile and non-prehensile tasks, some cable-driven systems, and some circuits with nonsmooth set-valued components. A global approach consists in a backstepping-like control strategy. The goal is to derive a unifying framework which can be easily adapted to all these various systems and tasks.

Switching LCS and DAEs

- We have gained a strong experience in the field of complementarity systems and distribution differential inclusions [42, 53], that may be seen as some kind of switching DAEs. More recently we have obtained preliminary results on the analysis of so-called differential-algebraic linear complementarity systems (DALCS) and descriptor-variable LCS (DVLCS), as well as on switching DAEs with state-dependent switching bilateral constraints. These systems can be seen as DAEs with added complementarity constraints, or as LCS with added equality constraints, or as DAEs with nonsmooth equality constraints. Their well-posedness (existence and uniqueness of solutions to the one-step nonsmooth problem of the implicit Euler scheme, existence and uniqueness of solutions to the continuous-time system) is non-trivial. The case of systems with state-jumps also requires careful analysis.
- A closely related subject is that of interconnections of LCSs or extensions of these (like differential inclusions with maximal monotone properties). The stability of the interconnected system is a topic of interest, as well as, the resulting collective behavior.

Dynamics of complex nonlinear networks, set-valued couplings

- The interconnections of uncertain dynamical systems is a topic of broad interest within the control community. For the case of nonlinear agents with set-valued coupling laws, many questions remain open regarding the resulting behavior of the network, as well as, their robustness properties against parametric uncertainties and external disturbances. The PhD thesis of Quang-Hung Pham focuses on such issues within the context of robust synchronization of LCSs.
- Recently, novel extensions of the concept of passivity have been studied for the analysis of systems away from equilibrium [81]. However, their relevance in the context of networks remains largely unexplored.
- Two-dimensional networks of oscillators with set-valued generalized Coulomb friction laws arise challenging questions regarding their dynamics (nonlinear oscillations, localized waves, excitability), with applications in earthquake dynamics and friction control.

- G. James has recently introduced in collaboration with F. Karbou (Centre d'Etudes de la Neige, Grenoble) a nonsmooth dynamical system on a network suitable for segmenting wet snow areas in SAR (synthetic-aperture radar) satellite images. The network corresponds to a large ensemble of pixels of a grayscale image, whose evolutions are coupled or uncoupled depending on their distance and local topography given by a digital elevation model. This yields an excitable dynamical system that tends to create domain walls surrounding snowy areas. The system provides very good identification results and arises nontrivial questions regarding its theoretical analysis, optimization (parameters, complexity) and generalizations.

4 Application domains

Nonsmooth dynamical systems arise in many application fields. We briefly highlight here some applications that have been treated in the BIPOP team and that we will continue in the TRIPOP team, as a validation for the research axes and also in terms of transfer.

In mechanics, the main instances of nonsmooth dynamical systems are multibody systems with Signorini's unilateral contact, set-valued (Coulomb-like) friction and impacts, or in continuum mechanics, ideal plasticity, fracture or damage. Some illustrations are given in Figure 3(a-f). Other instances of nonsmooth dynamical systems can also be found in electrical circuits with ideal components (see Figure 3(g)) and in control theory, mainly with sliding mode control and variable structure systems (see Figure 3(h)). More generally, every time a piecewise, possibly set-valued, model of systems is invoked, we end up with a nonsmooth system. This is the case, for instance, for hybrid systems in nonlinear control or for piecewise linear modeling of gene regulatory networks in mathematical biology (see Figure 3(i)). Another common example of nonsmooth dynamics is also found when the vector field of a dynamical system is defined as a solution of an optimization problem under constraints, or a variational inequality. Examples of this kind are found in optimal control theory, in dynamic Nash equilibrium or in the theory of dynamic flows over networks.

5 Social and environmental responsibility

As for the environmental footprint, we have already decided to drastically reduce our air travel and our participation in international conferences. For instance, trips of less than 10 hours by train should not be made by plane. International conferences should be coupled with a visit to colleagues or other scientific events. Concerning the computer equipment, it is not replaced before 5 years and we try to keep the office machines between 7 and 10 years.

Regarding the social impact, the emergence of the research axis 1 on natural gravitational hazards in relation to climate change and studies on systemic risk are a way to focus research on the major concerns of societies. Industrial collaborations are now also evaluated according to the social and environmental responsibility efforts of the partners.

The question of the social and environmental footprint and impact of our research will be discussed in more detail at our next team seminar.

6 New software, platforms, open data

6.1 New software

6.1.1 SICONOS

Name: Modeling, simulation and control of nonsmooth dynamical systems

Keywords: NSDS, MEMS, DCDC, SD, Collision, Friction, Mechanical multi-body systems

Scientific Description: The aim of this work is to provide a common platform for the simulation, modeling, analysis and control of abstract nonsmooth dynamical systems. Besides usual quality attributes for scientific computing software, we want to provide a common framework for various scientific



(a) Rockfall [51, 50, 62], granular and debris flows

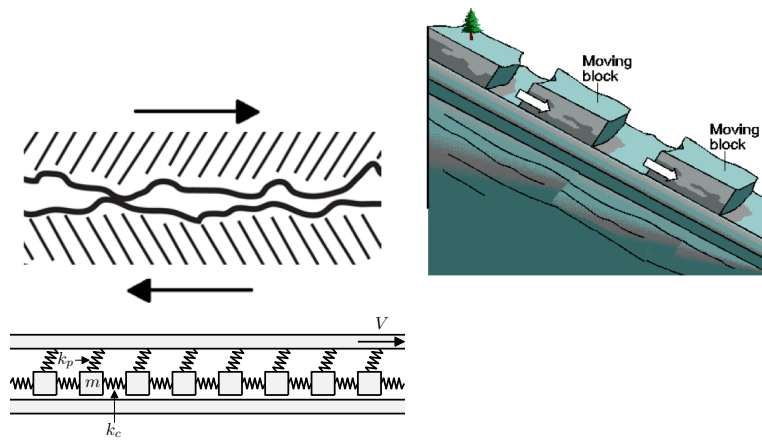

(b) Frictional interface and solitary waves in the Burridge-Knopoff model [83]

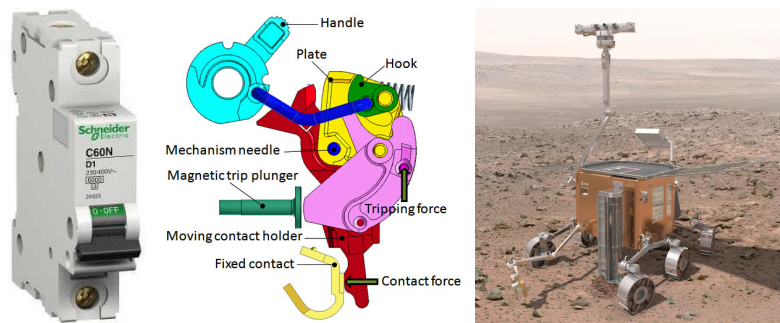

(c) Circuit breakers mechanisms [45] and Robots (ESA ExoMars Rover [28])

Figure 3: Application fields of nonsmooth dynamics (mechanics)

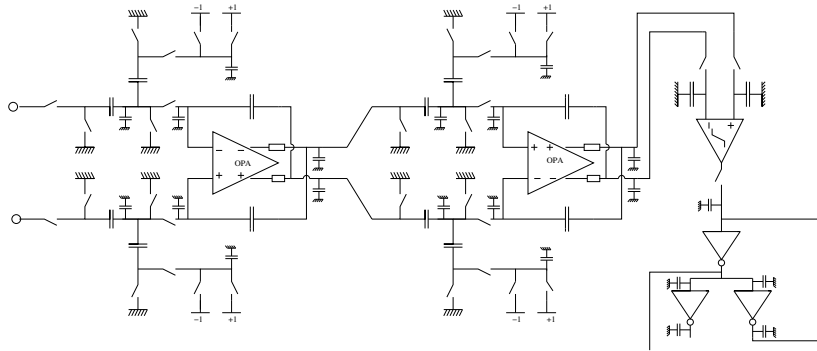

(d) Switched electrical circuits (delta-sigma converter) [37]

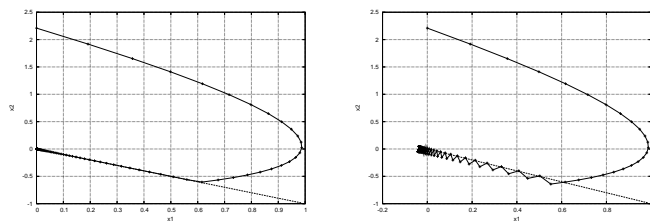
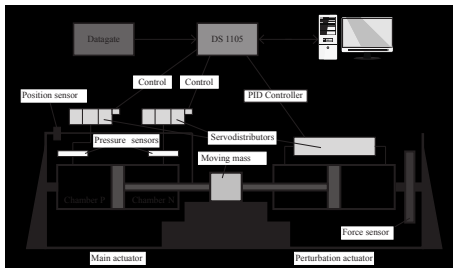

(e) Sliding mode control [41, 31, 73, 72, 82]

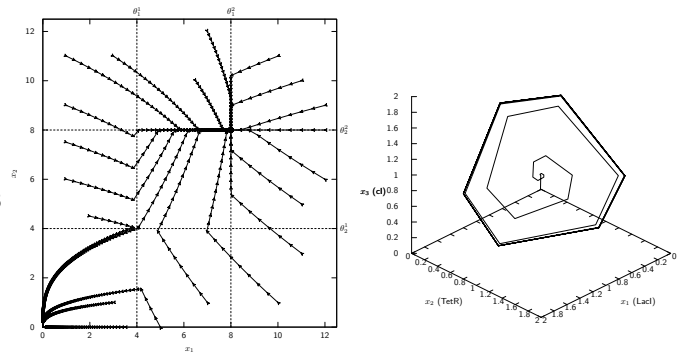
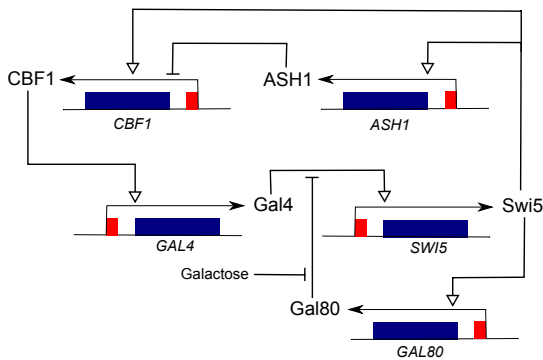

(f) Gene regulatory networks [44]

Figure 3: Application fields of nonsmooth dynamics (continued)

fields, to be able to rely on the existing developments (numerical algorithms, description and modeling software), to support exchanges and comparisons of methods, to disseminate the know-how to other fields of research and industry, and to take into account the diversity of users (end-users, algorithm developers, framework builders) in building expert interface in Python. After the requirements elicitation phase, the Siconos Software project has been divided into 5 work packages which are identified to software products:

- SICONOS/NUMERICS This library contains a set of numerical algorithms, already well identified, to solve non smooth dynamical systems. This library is written in low-level languages (C,F77) in order to ensure numerical efficiency and the use of standard libraries (Blas, Lapack, . . .)
- SICONOS/KERNEL This module is an object-oriented structure (C++) for the modeling and the simulation of abstract dynamical systems. It provides the users with a set of classes to describe their nonsmooth dynamical system (dynamical systems, interactions, nonsmooth laws, . . .) and to perform a numerical time integration and solving.
- SICONOS/FRONT-END. This module is mainly an auto-generated wrapper in Python which provides a user-friendly interface to the Siconos libraries. A scilab interface is also provided in the Front-End module.
- SICONOS/CONTROL This part is devoted to the implementation of control strategies of non smooth dynamical systems.
- SICONOS/MECHANICS. This part is dedicated to the modeling and the simulation of multi-body systems with 3D contacts, impacts and Coulomb's friction. It uses the Siconos/Kernel as simulation engine but relies on a industrial CAD library (OpenCascade and pythonOCC) to deal with complex body geometries and to compute the contact locations and distances between B-Rep description and on Bullet for contact detection between meshes.

Functional Description: Siconos is an open-source scientific software primarily targeted at modeling and simulating nonsmooth dynamical systems in C++ and in Python:

- Mechanical systems (rigid or solid) with unilateral contact and Coulomb friction and impact (nonsmooth mechanics, contact dynamics, multibody systems dynamics or granular materials).
- Switched Electrical Circuit such as electrical circuits with ideal and piecewise linear components: power converter, rectifier, Phase-Locked Loop (PLL) or Analog-to-Digital converter.
- Sliding mode control systems.
- Biology (Gene regulatory network). Other applications are found in Systems and Control (hybrid systems, differential inclusions, optimal control with state constraints), Optimization (Complementarity systems and Variational inequalities), Fluid Mechanics, and Computer Graphics.

Release Contributions: Main changes:

[numerics] add sparse linear solver with a sparse rhs based on csparse [numerics] new implementation of NM_LU_solve and NM_Cholesky_solve [kernel] new implementation of linear solvers in SimpleMatrix The class SimpleMatrix owns a internal NumericsMatrix thats is used for linear system solving, based on Siconos/Numerics [numerics] add balancing matrice framework [numerics] add freezing contacts in Gauss seidel solvers [externals] add LDL support [mechanics] modify broadphase for Bullet [numerics] render the truncation in NM_entry [numerics] add matrix versioning [misc] automates the generation of docker end-user images 'siconos-ready' [misc] build with ninja

URL: <https://nonsmooth.gricad-pages.univ-grenoble-alpes.fr/siconos/>

Contact: Vincent Acary

Participants: Franck Pérignon, Maurice Bremond, Vincent Acary

7 New results

7.1 Numerical Modeling for natural risk in mountains

7.1.1 Energy conservation and dissipation properties for elastodynamics with contact impact and friction

Participants: Vincent Acary, Nicholas Collins-Craft.

It has long been known that the standard implementation of impact and Coulomb friction leads to the creation of energy in cases where the sliding direction changes over the impact. The paper [43][26] proposes a time integration scheme for nonsmooth mechanical systems involving unilateral contact, impact and Coulomb friction, that respects the principles of discrete-time energy balance with positive dissipation. To obtain energetic consistency in the continuous time model, we work with an impact law inspired by the work of M. Frémond, which ensures that dissipation is positive, *i.e.* that the Clausius–Duhem inequality is satisfied. On this basis, we propose a time integration method based on the Moreau–Jean scheme with a discrete version of the Frémond impact law, and show that this method has the correct dissipation properties, *i.e.* no energy is created.

7.1.2 Numerical modeling of rockfall trajectory

Participants: Vincent Acary, Franck Bourrier.

Rockfall propagation models are routinely used for the quantitative assessment of rockfall hazard. Their capacities and limitations remain difficult to assess due to the limited amount of exhaustive experimental data at the slope scale.

The article [52] presents experiments of block propagation performed in a quarry located in Authume (France). A total of more than one hundred blocks were released on two propagation paths. The propagation of the blocks was assessed by measuring the block stopping points as well as their kinematics at specific locations of the paths, called evaluation screens. Significant variability of the stopping points and of the block kinematics at the evaluation screens was observed and preferential transit and deposit zones were highlighted. The analysis of the results showed predominant effect of topography, in particular that related to topographical discontinuities. Significant influence of local and small scale parameters (e.g. block orientation, local topography) was also highlighted. These conclusions are of particular interest for researchers or practitioners who would like to assess the relevance of propagation modelling tools considering this complex study site. In this configuration, the quality of block propagation simulations should notably rely on the accuracy of digital terrain models, and on the integration of local conditions effects using physically based approaches.

Complementary with the research held in [52], the predictive capabilities of block propagation models after a preliminary calibration phase is investigated. It is focused on models integrating the shape of blocks since, despite their sound physical bases, they remain less used than lumped-mass approaches due to their more recent popularisation. We first performed an expert-based calibration based on the use of the 2D model and, second, evaluated the predictive capabilities of the calibrated model in 2D and in 3D using the remaining part of the experimental results. The calibrated model simulations predict the main characteristics of the propagation : after a calibration phase on sufficient amount of soil types, the model may be used in a predictive manner. The adequacy between 2D and 3D simulations also favors applicability of the model since easier and faster calibrations based on 2D simulations only can be envisaged. As classically observed for block propagation models, the model is not sufficient to predict the details of the velocity and stopping points but provides accurate prediction of the global ranges of these quantities, in particular of the extreme values. To lift these limitations in terms of predictive capabilities, more advanced calibration procedures can constitute a promising perspective as it is studied in [49, 14, 15, 27].

7.1.3 Numerical modeling of fracture in solids

Participants: Vincent Acary, Franck Bourrier, Nicholas Collins-Craft.

In [59], a new extrinsic cohesive model is developed together with a consistent time-stepping scheme to simulate fracture in quasi-brittle material like rock or concrete. An extrinsic cohesive zone model with a novel unload-reload behaviour is developed in the framework of non-smooth mechanics. The model is extended to include the effects of dynamics with impact, and is discretised in such a way that it can be written as a Linear Complementarity Problem (LCP). This LCP is proved to be well-posed, and to respect the discrete energy balance of the system. Finally, the LCP system is validated numerically, in both statics and dynamics, by simple test cases, and more involved finite element simulations that correspond to standard test geometries in the literature. The results correspond well with those of other authors, while also demonstrating the simulations' ability to resolve with relatively large time steps while respecting the energetic balance. We are now working on the development of a model taking into account the tangential cohesion coupled with the Coulomb friction[22]. The objective is to propose a model coupled with hydro-thermal freezing and thawing phenomena in rock interfaces, which will be used to simulate the stability of cliffs in connection with the thawing of permafrost. This is still on-going work.

7.1.4 Variational approach for nonsmooth elasto-plastic dynamics with contact and impacts

Participants: Louis Guillet, Vincent Acary, Franck Bourrier, Olivier Goury.

The objective of this work [38] was the modelling and the numerical simulation of the response of elastoplastic structures to impacts. To this end, a numerical method is proposed that takes into account one-sided contact (Signorini condition) and impact phenomena together with plasticity in a monolithic solver, while accounting for the non-smooth character of the dynamics. The formulation of the plasticity and the contact laws are based on inclusions into normal cones of convex sets, or equivalently, variational inequalities following the pioneering work of Moreau (1974) and Halphen and Nguyen (1975), who introduced the assumptions of normal dissipation and of generalised standard materials (GSM) in the framework of associated plasticity with strain hardening. The proposed time-stepping method is an extension of the Jean and Moreau (1987) scheme for nonsmooth dynamics. The discrete energy balance shows that spurious numerical damping can be suppressed and that the scheme is in practice unconditionally stable. Furthermore, the finite-dimensional variational inequality at each time-step is well-posed and can be solved by optimization methods for convex quadratic programs, providing an interesting alternative to the return mapping algorithm coupled with a dedicated frictional contact method.

A contribution submitted to CSMA 2024[13] presents an implicit solver for non-associative plasticity problems based on the semi-smooth Newton method in the context of the material point method. The method is derived from the Implicit Standard Material and is easily compatible with various space discretization techniques, particularly the Material Point Method and the Finite Element Method. The solver converges quadratically, even for large time steps, although we have only demonstrated theoretical results for restricted cases. The method is demonstrated through a footing simulation.

7.1.5 Application of nonsmooth models of rockfall protection structures for the quantification of energy dissipation, warning and survey

Participants: Vincent Acary, Franck Bourrier, Ritesh Gupta.

This work is based on the nonsmooth model developed in [68] which simulates the response of a novel rockfall protection structure, made of piled-up concrete blocks interconnected via metallic components, subjected to impact of rock blocks.

This model was first used to investigate the key issue of energy dissipation in passive rockfall protection structures when exposed to impact by a rock block [5, 23]. Based on the work done in [43], energy dissipation due to friction between the system bodies and to plastic strain at contacts were quantified. The evolution with time of energy dissipation by each dissipative mechanism provides insights into the global structure response with time in terms of displacement and contact force amplitude. The influence of the model parameters on the contribution of these two dissipative mechanisms is evaluated. The variability in energy dissipation varying the impact conditions is addressed. In the end, this study reveals the benefits derived from a precise quantification of energy dissipation in passive rockfall protection structures.

As the viability of a rockfall protection structure is vital for hazard mitigation [4], the nonsmooth model developed in [68] was also used to assess the potential of inverse analysis applied to data collected on on-site rockfall protection structures exposed to real events. Extensive simulations allowed to investigate the variability in wall mechanical response against different impact conditions. The simulation results served as input data for developing the inverse analysis method. As a first application, it is proposed to use the inverse analysis to aid in remote decision-making shortly after an event, based on real-time measurements. Then, the use of inverse analysis to retrieve the impact condition characteristics (energy, location) from data collected after the event is addressed. The proposed approach appeared efficient for back-analysing (i.e., output to input) data related to the wall response for being used as a warning based on its displacement and damage to the wall.

7.2 Systemic risk

Participants: Arnaud Tonnelier, Vincent Acary.

The HANDY model is a human population dynamics model that has been proposed by *Montesharrei et al (2014)* to describe the interactions of a population with its natural environment. The system is obtained by adding an accumulated wealth to a prey-predator model of human and nature. In previous work, we analyzed the dynamics of the model with a special attention on bifurcations. We found that the system presents a bistable regime where two attractors, a sustainable equilibrium and cycles of prosperity and collapse, are separated in the phase space by a surface. We recently obtained a more precise characterization of this separatrix specially in the region where the population and the nature are vanishing.

The HANDY model is a highly simplified description of human-nature interactions. A more realistic but more complex model, the World3 model, has recently been considered. The model describes the interactions between the world population, the industrial and the agricultural sectors and the pollution. Preliminary results on the dynamics of the resource-capital subsystem have been obtained. Classical approaches coming from dynamical systems theory fail to analyze the behavior of the complete system due to its complexity and original/groundbreaking methods are necessary.

We used and developed loop dominance analysis to understand the dynamics of the World3 model. More precisely the so called loop eigenvalue elasticity analysis methods have been studied. This work is still in progress. Preliminary results have been obtained for some subsectors of the model.

Society collapse can originate from cascading failure. This phenomenon can occur between interconnected sectors or interdependent societies. The question is the following : under what conditions can the failure of one element in a network lead to a subsequent failure. In [11] we analyzed the propagation in simplified threshold models and derived conditions for successive switching of the elements.

7.3 Numerical solvers for frictional contact problems.

Participants: Vincent Acary, Maurice Brémond, Paul Armand.

In [40], we review several formulations of the discrete frictional contact problem that arises in space and time discretized mechanical systems with unilateral contact and three-dimensional Coulomb's friction. Most of these formulations are well-known concepts in the optimization community, or more generally, in the mathematical programming community. To cite a few, the discrete frictional contact problem can be formulated as variational inequalities, generalized or semi-smooth equations, second-order cone complementarity problems, or as optimization problems such as quadratic programming problems over second-order cones. Thanks to these multiple formulations, various numerical methods emerge naturally for solving the problem. We review the main numerical techniques that are well-known in the literature and we also propose new applications of methods such as the fixed point and extra-gradient methods with self-adaptive step rules for variational inequalities or the proximal point algorithm for generalized equations. All these numerical techniques are compared over a large set of test examples using performance profiles. One of the main conclusion is that there is no universal solver. Nevertheless, we are able to give some hints to choose a solver with respect to the main characteristics of the set of tests.

Recently, new developments have been carried out on applications of well-known numerical methods in optimization. With the visit of Paul Armand, Université de Limoges, we co-supervise a M2 internship, Maksym Shpakovych on the application of interior point methods for quadratic problem with second-order cone constraints. The results are encouraging [93], [85], [86]. A first publication on rolling friction has been published [36] and another publication [3] in *Optimization Methods and Software*.

7.4 Modeling of Impact Phenomena

Participants: Bernard Brogliato.

Multiple impacts (i.e., impacts which occur simultaneously in a mechanical system, thus not to be confused with finite accumulations of impacts, also known as a Zeno phenomenon) possess very specific features. As such their modeling is a non-trivial task. We propose a critical survey of multiple impact models in [17] (see also Chapter 6 in [2] for some further developments and informations concerning multiple impacts). Notice that a new version of the addendum/erratum of [2] is proposed in [19].

7.5 Analysis and Control of Set-Valued Systems

Participants: Bernard Brogliato, Félix Miranda-Villatoro, Aya Younes, Quang Hung Pham.

7.5.1 Discrete-time implicit Euler sliding-mode control

In [8] it is shown that some discrete-time algorithms, which have the property of finite-time stability and are written in an explicit form, are in fact the implicit (backward) Euler discretization of suitable set-valued systems. In other words, they can be written in the form of proximal-point algorithms using resolvents of maximal operators. This paves the way towards a unified framework for the calculation of sliding-mode controllers and differentiators when an implicit discretization is used.

The works [24] provide a fresh perspective on sliding mode techniques for control, observation, and differentiation via its discrete-time implementation with backward terms. In such context, the maximal monotonicity of the backward terms plays a central role for the well-posedness of the closed-loop, as well as, for its stability analysis. With such approach, the strong connections between sliding-mode control and optimization are shown via proximal-point algorithms. The manuscript also underscores the significance of passivity in the resulting closed-loop system, an aspect that has been overlooked within the broader community of sliding mode control. As a side-result a novel robust version of the proximal-point algorithm is presented and later employed to study the finite-time stability of the closed-loop system for the case of conventional (first-order) sliding-mode control. The manuscript delves into optimization and maximal monotone operators, underscoring the impact of set-valued control maps

and appropriate selection schemes leading to control strategies that do not suffer the common issue of numerical chattering.

In [6] a multivariable extension of the well-known supertwisting algorithm is proposed. New proofs on the finite-time stability and robustness of the proposed algorithm are provided. In addition, a novel approach for the computation of the control law, that is reminiscent of famous Douglas-Rachford splitting from proximal-point methods, is proposed and the stability properties of the closed-loop are thoroughly studied.

7.5.2 Well-posedness of Time-Varying Linear Complementarity Systems

Linear Complementarity Systems (LCS) as in (4) are a well-known class of nonsmooth nonlinear dynamical systems. Their analysis is more complex when the data are supposed to be time-dependent. In [9] we analyse several cases: when $D(t)$ is positive definite, when $D(t) = 0$, when the quadruple $(A(t), B(t), C(t), D(t))$ is passive (in the sense of Willems). Depending on the assumptions solutions may be absolutely continuous or right-continuous of local bounded variation. In parallel we propose in [10] an analysis for the characterisation of the range of the sum of two maximal monotone operators stemming from the Lur'e set-valued systems (i.e., a single-valued system with a set-valued operator in the negative feedback loop).

7.5.3 Multivalued Hamiltonian Systems in Discrete-Time

In [21] we analyse the stability properties of a class of discrete-time Hamiltonian systems, where both the lossless part and the dissipation function are considered multivalued. The backward Euler discretisation is studied. Examples are in feedback control algorithms (twisting, super-twisting algorithms), in mechanical systems, and in optimisation algorithms.

7.5.4 Emergent behaviors in nonlinear networks

The work [16] presents preliminary results for the analysis of emergent behaviors (self-sustained oscillations and static patterns) in networks of dynamical systems with interactions of activation-type locally and inhibitory-type in the long-range. Certificates, in the form of linear matrix inequalities, are obtained to study the existence of emergent static patterns or oscillations in the network. On the other hand, the work [7] studies the robust output synchronization problem in heterogeneous networks of dynamical systems with set-valued couplings described by hard-threshold mappings. It is shown that the interconnected systems is well-posed (an absolutely continuous solution exists) and the objective is reached in the presence of disturbances.

7.5.5 Tracking control of Linear Complementarity Systems

The work [12] is largely concerned with trajectory tracking in linear complementarity systems (LCS) where passivity (obtained via a suitable feedback controller) and maximal monotonicity (a property of the model) play a central role for the analysis and design of the closed-loop. Such approach allows to rely on linear matrix inequalities (LMIs) for the computation of the control gains. Cases with and without state-jumps, with and without parametric uncertainties, are carefully analyzed (indeed state jumps can naturally occur in LCS). Theoretical findings are illustrated with examples from circuits with set-valued, nonsmooth electronic components, contact mechanical systems with unilateral springs, and networks with unilateral interactions.

7.5.6 Tracking control in frictional oscillators

In [25] the tracking control of frictional oscillators, which can be recast into LCS, is considered. A frictional oscillator, as usually considered in the Nonlinear Dynamics literature, consists of a mass sliding/sticking on a moving belt. A blanket assumption is that the belt's velocity can be used as an input. Robustness with respect to uncertain friction coefficients is carefully analysed. The case of Stribeck friction (which yields a set-valued hypomonotone operator) is studied. The trajectory tracking control problem for frictional oscillators is further tackled in [20] where a backstepping passivity-based control algorithm is designed

and studied. In this case, both the pulley-belt dynamics and the sliding/sticking mass dynamics are taken into account in the controller design. The originality of the work lies in the fact that the couplings between both dynamics is realised with a set-valued maximal monotone mapping (in this case Coulomb's friction). Hence this extends more classical triangular structures where couplings are realised through smooth potential forces deriving from quadratic potentials (as in flexible-joint manipulators). Here again robustness with respect to uncertain friction coefficients is carefully studied. Also the discretisation of the controller (which involves a set-valued sliding-mode input) is analysed in detail.

8 Bilateral contracts and grants with industry

Participants: Vincent Acary, Bernard Brogliato.

8.1 Bilateral grants with industry

Schneider Electric

This action started in 2001 with the post-doc of V. Acary co-supported by Schneider Electric and CNRS. With some brief interruptions, this action is still active and should further continue. It concerns mainly the simulation and modeling of multi-body systems with contact, friction and impacts with the application for the virtual prototyping of electrical circuit breakers.

During these years, various forms of collaborations have been held. Two PhD thesis have been granted by Schneider Electric (D.E. Taha and N. Akhakar) accompanied with research contracts between INRIA and Schneider Electric. Schneider Electric participated also the ANR project Saladyn as a main partner.

Without going into deep details of the various actions over the years, the major success of this collaboration is the statistical tolerance analysis of the functional requirements of the circuit breakers with respect to clearance in joints and geometrical tolerances on the parts. Starting from the geometrical descriptions (CAD files) of a mechanism with prescribed tolerances on the manufacturing process, we perform worst-case analysis and Monte-Carlo simulations of the circuit breaker with Siconos and we record the variations in the functional requirements. The difficulty in such simulations are the modeling of contact with friction that models the joints with clearances. The results of these analysis enable Schneider Electric to define the manufacturing precision that has a huge impact of the production cost (Schneider Electric produces several millions of C60-type circuit breaker per year). Note that it is not possible to perform such simulations with the existing software codes of the market.

At the beginning, our interlocutor at Schneider Electric was the innovation (R&D) department. We have been working and discussing with the business unit, Division Power and Dinnov (M. Abadie, E. Boumediene, X. Herreros) in charge of designing and producing the circuit-breakers. The targeted users are the R&D engineers of Schneider Electric that use simulation tools for designing new models or improving existing circuit breakers. This collaboration continues with new modeling and simulation challenges (flexible parts, multiple impact laws) a collaboration launched in October 2023 with Dr Emmanuel Frangin. A PFE (projet de fin d'études) has been co-supervised in 2024 (Anis Zafirah Binti Mohd Zali, UT Belfort-Montbeliard), a second PFE will start in February 2025 (student: Rémy Roubinet, Ensimag).

STRMTG. Service Technique des remontées mécaniques et des transports guidés.

We have started with STRMTG a research contract about modelling, simulation and control of cable-transport systems. In such systems, the question of the coupling between the nonlinear dynamics of cables and their supports with unilateral contact and friction appears now to be determinant in order to increase the performances of the cableway systems, especially for urban transportation systems.

Safran Tech

In 2024, we have started a collaboration with Safran Tech through a post-doc (Simon Le Berre) on the simulation and modelling of flexible multi-body systems in the presence of impact and frictional contact.

9 Partnerships and cooperations

9.1 International research visitors

9.1.1 Visits of international scientists

Other international visits to the team

Fernando Castanos

Status researcher

Institution of origin: CINVESTAV Mexico

Country: Mexico

Dates: 01 September 2023 to 31 January 2024

Context of the visit: cooperation on discrete-time sliding modes, with Bernard Brogliato and Félix Miranda-Villatoro

Mobility program/type of mobility: sabbatical

9.2 European initiatives

9.2.1 Horizon Europe

LEMMA [LEMMA project on cordis.europa.eu](https://cordis.europa.eu/lemma)

Title: Landslide and avalanche Mechanics with Multiphysical data

Duration: From September 1, 2022 to August 31, 2024

Partners:

- INSTITUT NATIONAL DE RECHERCHE EN INFORMATIQUE ET AUTOMATIQUE (INRIA), France
- ECOLE POLYTECHNIQUE FEDERALE DE LAUSANNE (EPFL), Switzerland
- UNIVERSITE GRENOBLE ALPES (UGA), France

Inria contact: Vincent Acary

Coordinator:

Summary: Landslides and avalanches jointly cause approximately 150 deaths and €4.9 billion economic losses each year, with the impacts predicted to become more severe due to climate change. Mitigation and prevention of disasters requires accurate predictions of these phenomena, which due to their scale is only achievable via modelling and simulation. Accurate models of landslides in permafrost or avalanches must account for micro-scale (<1mm) processes such as cracks and shear bands that also involve thermal and hydrological effects that will be exacerbated by climate change. Such models do not currently exist. Further, this level of refinement is not computationally viable when modelling an entire mountainside, and so a new approach must be adopted.

This project will: 1) Develop new models for permafrost and snow subject to climate-change-induced loadings; 2) Use the new data-driven mechanics framework to transfer information from

these models to the scale of the mountainside; and 3) Simulate the effects of climate change on the Mont-Blanc massif at Chamonix. This will combine the researcher's experience with shear band models with the supervisor's expertise in crack models and optimisation techniques. A secondment at a group specialising in simulating landslides and avalanches will provide the expertise to implement the simulation on a real mountainside.

This interdisciplinary project will ideally set the researcher for a career in academia in Europe, while benefiting the community at Chamonix, in particular the guide's association, as they will be able to plan adaptations and mitigations for the effects of climate change, ensuring their tourism industry remains viable. Specialised multiphysical models that are adapted to permafrost and snow will advance the state-of-the-art significantly, and the implementation of optimisation techniques in data-driven mechanics has wide applicability throughout civil and mechanical engineering, geology and environmental science.

9.3 National initiatives

9.3.1 Project SsONDS LabEx PERSIVAL ANR-15-IDEX-02 and ANR-11-LABX-0025-01

Self-sustained Oscillations in Nonsmooth Dynamical Systems. October 2021 - September 2024. INRIA Grenoble TRIPOP team (F. Miranda-Villatoro, B. Brogliato) and Gipsa-Lab UGA (F. Ferrante). Coordinated by F. Miranda-Villatoro. The SsONDS project aims at developing theoretical methods for the analysis, design, and control of systems with robust self-sustained oscillations in environments with uncertainties (as for instance, lack of knowledge of certain parameters of the model, or the presence of external disturbances). Potential applications include the design of central pattern generators (CPGs) for motion control, and mathematical analysis of models from computational biology. Total fundings for TRIPOP = 99 keuros.

9.3.2 ANR SlimDisc

Participants: Felix Miranda-Villatoro, Bernard Brogliato.

SlimDisc "Sliding-Mode set-valued control and observation in finite and infinite dimensions: Discretization" is a project funded by The French National Research Agency (ANR). It is a collaborative project between Ecole Central de Nantes, Inria Lille, and Inria Grenoble, [SlimDisc](#). The start of the project is October 2024 for a duration of 4 years. This project follows two previous ANR projects on the same topic, with same partners ([ChaSlim](#) and [DigitSlid](#)).

The main goals of SlimDisc are the analysis and the experimental validation of set-valued sliding-mode controllers and state observers/differentiators, in discrete time, as well as the design of a toolbox dedicated to the computation and implementation of discrete-time controllers and differentiators. This will be tackled using mainly the Euler implicit and semi-implicit discretization methods. The key feature of this project is the development of discretization methods for both finite- and infinite-dimensional control systems.

9.3.3 ANR SPECULAR

Participants: Olivier Goury.

Simulation of Percutaneous Liver tumor Ablation in virtual Reality. The goal of this project is to develop an immersive simulation of needle-based procedures. Olivier Goury is responsible of Work Package 2 in collaboration with DEFROST at Inria Lille where the focus will be to speed up the numerical simulation using reduced-order modeling techniques and parallel programming. This project is coordinated by Stéphane Cotin at Inria Nancy and Hadrien Courtecuisse at Strasbourg University.

9.3.4 ANR MODEMSEA

Participants: Olivier Goury, Vincent Acary, Franck Bourrier, Franck Perignon, Maurice Bremond.

Numerical modeling of coastal defense structures using a fully coupled SPH-DEM-FEM model. This project was submitted to the ANR and we are awaiting the reviews. In collaboration with Ngoc-Son NGUYEN from GeM, University of Nantes.

9.3.5 PEPR Risques (Ex-IRIMA)

Participants: Olivier Goury, Vincent Acary, Franck Bourrier.

The IRiMa PEPR (integrated risk management for more resilient societies in an era of global change) is co-piloted by BRGM, CNRS and Grenoble-Alpes University. This exploratory PEPR, with a budget of €51.9 million over 8 years, brings together more than 30 partner institutions and laboratories. Within this PEPR, we are actively involved in the "Mountain" targeted project (PC) with the ANR IRIMONT funding application entitled "Assessment and mitigation of risks related to natural hazards in mountain territories in the global change context". The IRIMONT project looks at all the physical and social dimensions of natural hazards in mountain areas, from the characterisation of processes to decision-making and adaptation in a context of climate change and socio-environmental dynamics.

The project is structured in 3 work packages. Guillaume Chambon (INRAE/IGE), Marc Peruzetto (BRGM) and Vincent Acary are responsible for WP1 - Analysis and understanding of mountain risks and their components. This work package targets the gaps in knowledge and the scientific barriers concerning mountain risks and their components (hazards, vulnerability, exposure). To this end, it includes the acquisition and analysis of new data (instrumental, historical, etc.) and the development of new predictive models (mechanical, stochastic, decisional). This work package thus constitutes the "toolbox" of the IRIMONT project. However, as in the IRIMONT project as a whole, we are favouring an approach in which the questions are linked to the mountain terrain and its specific features, rather than a more disciplinary/methodological approach, and we are focusing on developments that can be best integrated with the expectations of the other work packages.

9.3.6 PEPR MATH VIVES - Mathematics for Life, Environment and Society

Participants: Vincent Acary, Franck Bourrier.

Within this PEPR, we are actively involved in the targeted project Complex Flows coordinated by Didier Bresch and Farang Radjai.

10 Dissemination

10.1 Promoting scientific activities

10.1.1 Scientific events: organisation

Olivier Goury co-organised the [SOFA America workshop on Soft Robotics](#) in Polytechnique Montreal, May 30-31st 2024.

Member of the conference program committees

- Vincent Acary is a member of the [ICCCM 2025](#) program committee.
- Vincent Acary was a member of the [CMIS 2024](#) program committee of the Contact Mechanics International Symposium (CMIS).

Reviewer

- Olivier Goury : reviewer in 2024 for SIGGRAPH 2024, Robosoft 2025,

10.1.2 Journal

Member of the editorial boards

- Bernard Brogliato, Guest Managing Editor of the special issue Nonsmooth Dynamical Systems: Analysis, Control and Optimization, in Nonlinear Analysis: Hybrid Systems, [NAHS](#)
- Vincent Acary is editor and co-founder of the [Journal of Theoretical, Computational and Applied Mechanics \(JTCAM\)](#), one of the few diamond open access journals, and the only overlay journal in Mechanics.

Reviewer - reviewing activities

- A. Tonnelier: reviewer in 2024 for Physical Review E and Nonlinear Analysis: Real World Applications.
- F. Bourrier : reviewer in 2024 for Landslides, Computers and Geotechnics, Engineering Geology, Granular Matter and Int. J. for Num. and Anal. Met. in Geomechanics
- Olivier Goury : reviewer in 2024 for International Journal of Robotics Research (IJRR), IEEE Robotics and Automation Letters (RA-L), SIGGRAPH
- F. Miranda Villatoro: reviewer in 2024 for IEEE Transactions in Automatic Control and Automatica journals.
- Bernard Brogliato is reviewer for Automatica, IEEE Transactions on Automatic Control, SIAM J. Control and Optimization, Systems and Control Letters, IEEE Control Systems Letters, SIAM Journal on Optimization, etc.
- Vincent Acary was reviewer for Computer Methods in Applied Mechanics and Engineering (CMAME), International Journal for Numerical Methods in Engineering(IJNME), IEEE Transactions on Robotics (IEEE-TRO), Nonlinear Analysis: Hybrid Systems (NA-HS), Mechanical Systems and Signal Processing (MSSP)

10.1.3 Invited talks

- Olivier Goury at the Journée inter-GDR Robotique-MACS-MéPhy 19/11/2024: Numerical Simulation for Control and Design of Soft Robots
- Felix Miranda at the Indo-French seminar on advances in robust nonlinear control for uncertain dynamical systems: theory and applications (15-19 April 2024), Indian Institute of Technology Roorkee, Roorkee, India.
- Bernard Brogliato gave an invited talk at the conference Control of State Constrained Dynamical Systems, Padova, September 2024. [CoSCDS24](#)
- Vincent Acary is invited to give a keynote lecture at [ICCCM 2025](#).

10.1.4 Leadership within the scientific community

- Vincent Acary is the coordinator with R. Leine of the European Network for Nonsmooth Dynamics (ENNSD)
- Vincent Acary is a member of the Comité National Français de Mécanique (CNFM) that is the national instance member of IUTAM, the International Union of Theoretical and Applied Mechanics (IUTAM).

10.1.5 Scientific expertise

Olivier Goury was reviewer for the ANR.

10.1.6 Research administration

Olivier Goury is an elected member of the CE (Commission d'évaluation) of Inria.

10.2 Teaching - Supervision - Juries

10.2.1 Teaching

- Master : Franck Bourrier, 5H éq TD Modélisation des chutes de blocs, Master GAIA, Université Savoie Mont-Blanc.
- Master : Franck Bourrier, 30H éq TD Slope Stability, Polytech' Grenoble 4th year, Université Grenoble Alpes.
- Master : Franck Bourrier, 30H éq TD, Calcul des Structures, Polytech Grenoble, 4th year, Université Grenoble Alpes.
- Master : Félix Miranda-Villatoro, 15 H CM, Distributed Optimization, Master2 MISCIT PhITEM, Université Grenoble Alpes.
- Licence : Louis Guillet, 31.5H éq TD Analyse réelle, DLST PCMM 1st year, Université Grenoble Alpes.
- Licence : Nicholas Collins-Craft, 53H éq CTD & TP Analyse élémentaire et introduction au calcul scientifique, DLST IMA 1st year, Université Grenoble Alpes.

10.2.2 Supervision

- Antoine Cordoba, Postdoc, supervised by Arnaud Tonnelier in collaboration with S. Fenet and P.Y. Longaretti (INRIA - STEEP) (01/09/2024 - 31/08/2025)
- Aya Younes, Ph.D. student, supervised by Bernard Brogliato and Felix Miranda-Villatoro (01/10/2021 until 01/10/2024) [18].
- Quang Hung Pham, Ph.D. student, supervised by Bernard Brogliato and Felix Miranda-Villatoro (01/12/2022 until 01/12/2025).
- Raphael Gandin, Master ENS Ulm, Paris , supervised by Arnaud Tonnelier (01/06/2024 - 30/07/2024).
- Sandra Belin-Gorsic, Ph.D. student Univ. Geneva, supervised by Franck Bourrier in collaboration with M. Farvacque, C. Corona and M. Stoffel.
- Raj Kiran Dhiman, PhD student Univ. Panjab, supervised by Franck Bourrier in collaboration with M. Takur.
- Louis Guillet, PhD student, supervised by Vincent Acary, Franck Bourrier and Olivier Goury.

- Tanguy Navez, PhD student, supervised by Olivier Goury and Christian Duriez. Thesis Completed 04/10/24.
- Félix Vanneste, PostDoc, supervised by Olivier Goury on ANR SPECULAR.
- Samuel M. Youssef, PostDoc, supervised by Olivier Goury on ANR SPECULAR.
- Florian Vincent, PhD student, supervised by Vincent Acary and Jérôme Malick.
- Chloé Gergely, PhD student, supervised by Vincent Acary and Franck Bourrier.
- Mattéo Oziol, PhD student, supervised by Vincent Acary, Franck Bourrier and Thierry Faug.
- Nicholas Collins-Craft, postDoc supervised by Vincent Acary, Franck Bourrier
- Ritesh Gupta postDoc supervised by Vincent Acary, Franck Bourrier
- Simon Le Berre postDoc supervised by Vincent Acary, Franck Bourrier

10.2.3 Juries

- Bernard Brogliato (Ph.D. jury of Yu Zhou, supervised by A; Polyakov and Gang Zheng, INRIA Lille, 05/12/2024, president).
- Arnaud Tonnelier, Ph.D. jury of Jordi Penalva Vadell, Universitat de les Illes Balears, 24/01/2024, Examiner.
- Franck Bourrier, Ph.D. jury of Bruma Morganna Mendonca De Souza, supervised by J. Benoit and M. Bost, University of New Hampshire-Durham-USA and ENTPE, 06/04/2024, Reviewer.
- Olivier Goury was member of the Inria jury for recruitment of CRCN-ISFP at Inria Lille in 2024.
- Vincent Acary, Ph.D. jury of Clément Berger, supervised by Paul Vigneaux, ENS Lyon (09/2024). Reviewer.
- Vincent Acary, Ph.D. jury of Jonas Breuling, supervised by Remco Leine, TU Stuttgart, Germany (10/2024). Reviewer.
- Vincent Acary, Ph.D. jury of Maarten Jongeneel, supervised by Alessandro Saccon and Nathan van de Wouw, TU Eindhoven, The Netherlands (10/2024). Reviewer.
- Vincent Acary, HDR jury of Jérémy Bleyer, Ecole Nationale des Ponts et Chaussées (ENPC) (11/2024). Reviewer.

10.3 Popularization

- Bernard Brogliato participated in [Modélisation Fibres](#).

11 Scientific production

11.1 Major publications

- [1] V. Acary and B. Brogliato. *Numerical methods for nonsmooth dynamical systems. Applications in mechanics and electronics*. English. Lecture Notes in Applied and Computational Mechanics 35. Berlin: Springer. xxi, 525~p., 2008.
- [2] B. Brogliato. *Nonsmooth Mechanics: Models, Dynamics and Control*. Springer International Publishing Switzerland; Communications and Control Engineering, 2016. DOI: [10.1007/978-3-319-28664-8](https://doi.org/10.1007/978-3-319-28664-8). URL: <https://inria.hal.science/hal-01236953> (cit. on pp. 3, 21).

11.2 Publications of the year

International journals

- [3] V. Acary, P. Armand, H. Minh Nguyen and M. Shpakovych. ‘Second order cone programming for frictional contact mechanics using interior point algorithm’. In: *Optimization Methods and Software*. Special issue honoring Oleg Burdakov 39.3 (2024), pp. 634–663. DOI: [10.1080/10556788.2023.2296438](https://doi.org/10.1080/10556788.2023.2296438). URL: <https://hal.science/hal-03913568> (cit. on p. 21).
- [4] S. Lambert and F. Bourrier. ‘Flexible Facing Systems for Surficial Slope Stabilisation: A Literature Review’. In: *Geotechnical and Geological Engineering* 42 (2024), pp. 5425–5446. DOI: [10.1007/s10706-024-02883-5](https://doi.org/10.1007/s10706-024-02883-5). URL: <https://hal.science/hal-04674338> (cit. on p. 20).
- [5] S. Lambert, R. Gupta, F. Bourrier and V. Acary. ‘On the simulation-based quantification of energy dissipation in rockfall protection structures: Case of an articulated wall modelled with the NSCD method’. In: *Rock Mechanics and Rock Engineering* (2024), pp. 1–47. DOI: [10.1007/s00603-024-04222-9](https://doi.org/10.1007/s00603-024-04222-9). URL: <https://hal.science/hal-04767017>. In press (cit. on p. 20).
- [6] F. Miranda-Villatoro. ‘A Variational Approach to the Design of Multivariable Discrete-time Super-twisting-like Algorithms’. In: *IEEE Transactions on Automatic Control* (2024), pp. 1–12. DOI: [10.1109/TAC.2024.3484308](https://doi.org/10.1109/TAC.2024.3484308). URL: <https://inria.hal.science/hal-04511213> (cit. on p. 22).
- [7] F. Miranda-Villatoro. ‘Robust output convergence of heterogeneous networks via nonsmooth hard-threshold couplings’. In: *Nonlinear Analysis: Hybrid Systems* 52 (May 2024), p. 101459. DOI: [10.1016/j.nahs.2023.101459](https://doi.org/10.1016/j.nahs.2023.101459). URL: <https://hal.science/hal-04333265> (cit. on p. 22).
- [8] F. Miranda-Villatoro, F. Castañón and B. Brogliato. ‘Finite-time convergent discrete-time algorithms: from explicit to backward schemes’. In: *Automatica* (2024). URL: <https://inria.hal.science/hal-04516369>. In press (cit. on p. 21).
- [9] Q. H. Pham, B. Brogliato and F. Miranda-Villatoro. ‘Well-Posedness of Passive Time-Varying Linear Cone Complementarity Systems’. In: *Journal of Convex Analysis* (18th Apr. 2024). URL: <https://inria.hal.science/hal-04551029>. In press (cit. on p. 22).
- [10] Q.-H. Pham and B. Brogliato. ‘Correction to "Analysis of the Implicit Euler Time-Discretization of a Class of Descriptor-Variable Linear Cone Complementarity Systems", J. Convex Analysis 29/2 (2022) 481–517’. In: *Journal of Convex Analysis* 31.3 (23rd July 2024), pp. 1035–1037. URL: <https://inria.hal.science/hal-04704041> (cit. on p. 22).
- [11] A. Tonnelier. ‘Exact solutions for signal propagation along an excitable transmission line’. In: *Physical Review E* 109 (18th Jan. 2024), p. 014219. DOI: [10.1103/PhysRevE.109.014219](https://doi.org/10.1103/PhysRevE.109.014219). URL: <https://hal.science/hal-04349848> (cit. on p. 20).
- [12] A. Younes, F. Miranda-Villatoro and B. Brogliato. ‘Trajectory tracking in linear complementarity systems with and without state jumps: A passivity approach’. In: *Nonlinear Analysis: Hybrid Systems* 54 (Nov. 2024), p. 101520. DOI: [10.1016/j.nahs.2024.101520](https://doi.org/10.1016/j.nahs.2024.101520). URL: <https://inria.hal.science/hal-04842301> (cit. on p. 22).

National peer-reviewed Conferences

- [13] L. Guillet, V. Acary, F. Bourrier and O. Goury. ‘Semi-smooth Newton method for nonassociative plasticity using the bi-potential approach’. In: 16ème Colloque National en Calcul de Structures (CSMA 2024). Hyères, France, 2024. URL: <https://hal.science/hal-04611037> (cit. on p. 19).

Conferences without proceedings

- [14] R. K. Dhiman, F. Bourrier and M. Thakur. ‘A new rockfall propagation model: Examining rockfall risk in Manikaran, NW Himalaya, India’. In: ISL 2024 - 14th International Symposium on Landslides. Chambéry, France, 2024, pp. 1–4. URL: <https://hal.science/hal-04700928> (cit. on p. 18).
- [15] P. Mahjoub-Bonnaire, F. Bourrier, L. Oger and G. Chambon. ‘Modeling particle impacts on granular media for the analysis of aeolian saltation’. In: EGU general Assembly 2024. Vienne, Austria, 9th Mar. 2024, pp. 1–1. DOI: [10.5194/egusphere-egu24-15069](https://doi.org/10.5194/egusphere-egu24-15069). URL: <https://hal.science/hal-04700940> (cit. on p. 18).

- [16] F. Miranda-Villatoro. ‘A dominance approach for the analysis of emergent patterns in networks’. In: ENOC 2024 - 11th European Nonlinear Oscillations Conference. Delft, Netherlands, 2024, pp. 1–2. URL: <https://hal.science/hal-04607079> (cit. on p. 22).

Scientific book chapters

- [17] B. Brogliato. ‘Multiple-Impact Modeling in Multibody Systems’. In: *Handbook on Nonlinear Dynamics, Vibrations and Acoustics; Volume 1: Nonlinear Dynamics and Vibrations: Fundamental Concepts and Analytical Methods*. World Scientific Publishing, 20th Aug. 2024, pp. 1–39. URL: <https://inria.hal.science/hal-04673788>. In press (cit. on p. 21).

Doctoral dissertations and habilitation theses

- [18] A. Younes. ‘Trajectory Tracking in Linear Complementarity Systems and Frictional Oscillators’. Université Grenoble Alpes, 1st Oct. 2024. URL: <https://hal.science/tel-04757813> (cit. on p. 28).

Reports & preprints

- [19] B. Brogliato. *Nonsmooth Mechanics. Models, Dynamics and Control : Erratum/Addendum*. INRIA Centre de l’Université Grenoble - Alpes, 7th Jan. 2024, pp. 1–19. URL: <https://inria.hal.science/hal-01331565> (cit. on p. 21).
- [20] B. Brogliato, F. Miranda-Villatoro and A. Younes. *Backstepping passivity-based trajectory tracking control of frictional oscillators: continuous and discrete time analyses*. 16th Dec. 2024. URL: <https://inria.hal.science/hal-04842497> (cit. on p. 22).
- [21] F. Castaños, F. A. Miranda-Villatoro and B. Brogliato. *Multivalued Hamiltonian Systems with Multivalued Dissipation: Analysis of the Backward-Euler Discretisation*. 26th June 2024. URL: <https://inria.hal.science/hal-04625231> (cit. on p. 22).
- [22] N. A. Collins-Craft, F. Bourrier and V. Acary. *On the formulation and implementation of mixed mode I and mode II extrinsic cohesive zone models with contact and friction*. 8th Feb. 2024. URL: <https://inria.hal.science/hal-04447397> (cit. on p. 19).
- [23] R. Gupta, F. Bourrier and S. Lambert. *Bayesian inference based inverse analysis of the impact response of a rockfall protection structure: Application towards warning and survey*. 2024. DOI: 10.1016/j.engstruct.2024.118800. URL: <https://hal.science/hal-04582717> (cit. on p. 20).
- [24] F. Miranda-Villatoro, F. Castanos and B. Brogliato. *When proximal-point algorithms meet set-valued systems. An Optimization point of view of discrete-time sliding modes*. 26th June 2024. URL: <https://inria.hal.science/hal-04626631> (cit. on p. 21).
- [25] A. Younes, F. Miranda-Villatoro and B. Brogliato. *Passivity-based Trajectory Tracking Control in Frictional Oscillators with Set-valued Friction*. INRIA Centre de l’Université Grenoble-Alpes, 29th Nov. 2024, pp. 1–46. URL: <https://inria.hal.science/hal-04810905> (cit. on p. 22).

Other scientific publications

- [26] V. Acary and N. A. Collins-Craft. *Open Review of "On the Moreau-Jean scheme with the Frémond impact law: energy conservation and dissipation properties for elastodynamics with contact, impact and friction"*. Dec. 2024. URL: <https://hal.science/hal-04819313> (cit. on p. 18).
- [27] M. Cathala, F. Magnin, L. Ravel, L. Dorren, F. Berger, F. Bourrier, N. Zuanon and P. Deline. ‘Mapping release and propagation areas of permafrost-related rock slope failures in the French Alps: A new methodological approach at regional scale’. In: EGU 2024 - EGU General Assembly. Vienna, Austria, 8th Mar. 2024. DOI: 10.5194/egusphere-egu24-8202. URL: <https://hal.science/hal-04755861> (cit. on p. 18).

11.3 Cited publications

- [28] V. Acary, M. Brémond, K. Kapellos, J. Michalczyk and R. Pissard-Gibollet. ‘Mechanical simulation of the Exomars rover using Siconos in 3DROV’. In: *ASTRA 2013 - 12th Symposium on Advanced Space Technologies in Robotics and Automation*. ESA/ESTEC. Noordwijk, Netherlands, 2013 (cit. on p. 15).
- [29] V. Acary, M. Brémond, T. Koziara and F. Pérignon. *FCLIB: a collection of discrete 3D Frictional Contact problems*. Technical Report RT-0444. INRIA, 2014, p. 34 (cit. on p. 12).
- [30] V. Acary and B. Brogliato. *Numerical methods for nonsmooth dynamical systems. Applications in mechanics and electronics*. English. Lecture Notes in Applied and Computational Mechanics 35. Berlin: Springer. xxi, 525 p., 2008 (cit. on pp. 3, 6).
- [31] V. Acary, B. Brogliato and Y. V. Orlov. ‘Chattering-Free Digital Sliding-Mode Control With State Observer and Disturbance Rejection’. In: *IEEE Transactions on Automatic Control* 57.5 (2012), pp. 1087–1101. , (cit. on p. 16).
- [32] V. Acary and Y. Monerie. *Nonsmooth fracture dynamics using a cohesive zone approach*. Anglais. Research Report RR-6032. INRIA, 2006, p. 56 (cit. on p. 9).
- [33] V. Acary. ‘Energy conservation and dissipation properties of time-integration methods for the nonsmooth elastodynamics with contact’. In: *ZAMM - Journal of Applied Mathematics and Mechanics / Zeitschrift für Angewandte Mathematik und Mechanik* 96.5 (2016), pp. 585–603. , (cit. on p. 8).
- [34] V. Acary. ‘Higher order event capturing time-stepping schemes for nonsmooth multibody systems with unilateral constraints and impacts.’ In: *Applied Numerical Mathematics* 62.10 (2012), pp. 1259–1275. , (cit. on p. 8).
- [35] V. Acary. ‘Projected event-capturing time-stepping schemes for nonsmooth mechanical systems with unilateral contact and Coulomb’s friction’. In: *Computer Methods in Applied Mechanics and Engineering* 256 (2013), pp. 224–250. , (cit. on p. 8).
- [36] V. Acary, P. Armand and H. M. Nguyen. ‘High-accuracy computation of rolling friction contact problems’. In: *9th NAFOSTED Conference on Information and Computer Science (NICS)*. Ho Chi Minh City, Vietnam, Vietnam: IEEE, Oct. 2022. DOI: [10.1109/NICS56915.2022](https://doi.org/10.1109/NICS56915.2022). URL: <https://inria.hal.science/hal-03741048> (cit. on p. 21).
- [37] V. Acary, O. Bonnefon and B. Brogliato. *Nonsmooth modeling and simulation for switched circuits*. Springer Netherlands, 2011. , (cit. on pp. 6, 16).
- [38] V. Acary, F. Bourrier and B. Viano. ‘Variational approach for nonsmooth elasto-plastic dynamics with contact and impacts’. In: *Computer Methods in Applied Mechanics and Engineering* 414 (Sept. 2023), p. 116156. DOI: [10.1016/j.cma.2023.116156](https://doi.org/10.1016/j.cma.2023.116156). URL: <https://inria.hal.science/hal-03978387> (cit. on p. 19).
- [39] V. Acary, M. Brémond and O. Huber. ‘Advanced Topics in Nonsmooth Dynamics.’ In: *Advanced Topics in Nonsmooth Dynamics*. To appear. Springer International Publishing, 2018. Chap. On solving frictional contact problems: formulations and comparisons of numerical methods. Pp. 375–457. , (cit. on p. 12).
- [40] V. Acary, M. Brémond and O. Huber. ‘On solving contact problems with Coulomb friction: formulations and numerical comparisons’. In: *Advanced Topics in Nonsmooth Dynamics - Transactions of the European Network for Nonsmooth Dynamics*. Ed. by S. I. Publishing. June 2018, pp. 375–457. DOI: [10.1007/978-3-319-75972-2_10](https://doi.org/10.1007/978-3-319-75972-2_10). URL: <https://hal.inria.fr/hal-01878539> (cit. on p. 21).
- [41] V. Acary and B. Brogliato. ‘Implicit Euler numerical scheme and chattering-free implementation of sliding mode systems’. In: *Systems & Control Letters* 59.5 (2010). doi:10.1016/j.sysconle.2010.03.002, pp. 284–293. , (cit. on p. 16).
- [42] V. Acary, B. Brogliato and D. Goeleven. ‘Higher order Moreau’s sweeping process: mathematical formulation and numerical simulation’. In: *Mathematical Programming* 113.1 (2008), pp. 133–217. , (cit. on pp. 5, 11, 13).

- [43] V. Acary and N. A. Collins-Craft. ‘On the Moreau–Jean scheme with the Frémond impact law: energy conservation and dissipation properties for elastodynamics with contact, impact and friction’. working paper or preprint. 2024. URL: <https://inria.hal.science/hal-04230941> (cit. on pp. 18, 20).
- [44] V. Acary, H. de Jong and B. Brogliato. ‘Numerical Simulation of Piecewise-Linear Models of Gene Regulatory Networks Using Complementarity Systems Theory’. In: *Physica D: Nonlinear Phenomena* 269 (2013), pp. 103–119. , (cit. on pp. 7, 11, 16).
- [45] N. Akhadkar, V. Acary and B. Brogliato. ‘Multibody systems with 3D revolute joint clearance, modeling, numerical simulation and experimental validation: an industrial case study’. In: *Multibody System Dynamics* 42.3 (2017), pp. 249–282. , (cit. on pp. 10, 15).
- [46] R. Alur, C. Courcoubetis, N. Halbwachs, T. Henzinger, P.-H. Ho, X. Nicollin, A. Olivero, J. Sifakis and S. Yovine. ‘The algorithmic analysis of hybrid systems.’ In: *Theoretical Computer Science* 138.1 (1995), pp. 3–34. , (cit. on p. 7).
- [47] A. Beck and M. Teboulle. ‘A Fast Iterative Shrinkage-Thresholding Algorithm for Linear Inverse Problems’. In: *SIAM Journal on Imaging Sciences* 2.1 (2009), pp. 183–202. eprint: <http://dx.doi.org/10.1137/080716542>. (Cit. on p. 12).
- [48] M. di Bernardo, C. Budd, A. Champneys and P. Kowalczyk. *Piecewise-smooth dynamical systems: theory and applications*. Applied mathematical sciences. London: Springer, 2008 (cit. on p. 3).
- [49] F. Bourrier and V. Acary. ‘Predictive capabilities of 2D and 3D block propagation models integrating block shape assessed from field experiments’. In: *Rock Mechanics and Rock Engineering* 55.2 (2022), pp. 591–609 (cit. on p. 18).
- [50] F. Bourrier, F. Berger, P. Tardif, L. Dorren and O. Hungr. ‘Rockfall rebound: comparison of detailed field experiments and alternative modelling approaches’. In: *Earth Surface Processes and Landforms* 37.6 (2012), pp. 656–665. (Cit. on pp. 9, 15).
- [51] F. Bourrier, L. Dorren, F. Nicot, F. Berger and F. Darve. ‘Toward objective rockfall trajectory simulation using a stochastic impact model’. In: *Geomorphology* 110.3-4 (2009), pp. 68–79. , (cit. on pp. 9, 15).
- [52] F. Bourrier, D. Toe, B. Garcia, J. Baroth and S. Lambert. ‘Experimental investigations on complex block propagation for the assessment of propagation models quality’. In: *Landslides* 18.2 (Feb. 2021), pp. 639–654. DOI: [10.1007/s10346-020-01469-5](https://hal.archives-ouvertes.fr/hal-03129220). URL: <https://hal.archives-ouvertes.fr/hal-03129220> (cit. on p. 18).
- [53] B. Brogliato and L. Thibault. ‘Existence and uniqueness of solutions for non-autonomous complementarity dynamical systems’. In: *J. Convex Anal.* 17.3-4 (2010), pp. 961–990 (cit. on p. 13).
- [54] O. Brüls, V. Acary and A. Cardona. ‘Simultaneous enforcement of constraints at position and velocity levels in the nonsmooth generalized- α scheme’. English. In: *Computer Methods in Applied Mechanics and Engineering* 281 (2014), pp. 131–161. , (cit. on p. 8).
- [55] B. Caillaud. *Hybrid vs. nonsmooth dynamical systems*. synchron. <http://synchron2014.inria.fr/wp-content/uploads/sites/13/2014/12/Caillaud-nsds.pdf>. 2014 (cit. on p. 11).
- [56] G. Capobianco and S. R. Eugster. ‘Time finite element based Moreau-type integrators’. In: *International Journal for Numerical Methods in Engineering* 114.3 (2018), pp. 215–231. eprint: <https://onlinelibrary.wiley.com/doi/pdf/10.1002/nme.5741>. (Cit. on p. 8).
- [57] L. P. Carloni, R. Passerone, A. Pinto and A. L. Angiovanni-Vincentelli. ‘Languages and tools for hybrid systems design’. In: *Foundations and Trends in Electronic Design Automation* 1.1/2 (2006), pp. 1–193. , (cit. on p. 11).
- [58] Q.-z. Chen, V. Acary, G. Virlez and O. Brüls. ‘A nonsmooth generalized- α scheme for flexible multibody systems with unilateral constraints’. In: *International Journal for Numerical Methods in Engineering* 96.8 (2013), pp. 487–511. , (cit. on p. 8).
- [59] N. A. Collins-Craft, F. Bourrier and V. Acary. ‘On the formulation and implementation of extrinsic cohesive zone models with contact’. In: *Computer Methods in Applied Mechanics and Engineering* 400 (Oct. 2022), p. 115545. DOI: [10.1016/j.cma.2022.115545](https://hal.science/hal-03371667). URL: <https://hal.science/hal-03371667> (cit. on p. 19).

- [60] R. W. Cottle, J. Pang and R. E. Stone. *The Linear Complementarity Problem*. Boston, MA: Academic Press, Inc., 1992 (cit. on pp. 7, 8).
- [61] L. Dorren, F. Berger, M. Jonsson, M. Krautblatter, M. Mölk, M. Stoffel and A. Wehrli. ‘State of the art in rockfall – forest interactions’. In: *Schweizerische Zeitschrift für Forstwesen* 158.6 (2007), pp. 128–141. eprint: <https://doi.org/10.3188/szf.2007.0128>. , (cit. on p. 9).
- [62] S. Dupire, F. Bourrier, J.-M. Monnet, S. Bigot, L. Borgniet, F. Berger and T. Curt. ‘Novel quantitative indicators to characterize the protective effect of mountain forests against rockfall’. In: *Ecological Indicators* 67 (2016), pp. 98–107. , (cit. on pp. 9, 15).
- [63] F. Facchinei and J. S. Pang. *Finite-dimensional Variational Inequalities and Complementarity Problems*. Vol. I & II. Springer Series in Operations Research. Springer New York, 2003. , (cit. on p. 7).
- [64] A. F. Filippov. *Differential Equations with Discontinuous Right Hand Sides*. Dordrecht, the Netherlands: Kluwer, 1988 (cit. on pp. 3, 6, 11).
- [65] M. P. Friedlander and D. Orban. ‘A primal–dual regularized interior-point method for convex quadratic programs’. In: *Mathematical Programming Computation* 4.1 (2012), pp. 71–107. (Cit. on p. 12).
- [66] F. Génot and B. Brogliato. ‘New results on Painlevé Paradoxes’. In: *European Journal of Mechanics - A/Solids* 18.4 (1999), pp. 653–677. , (cit. on p. 10).
- [67] D. Goeleven. *Complementarity and Variational Inequalities in Electronics*. Academic Press, 2017 (cit. on p. 3).
- [68] R. Gupta, F. Bourrier, V. Acary and S. Lambert. ‘Bayesian interface based calibration of a novel rockfall protection structure modelled in the Non-smooth contact dynamics framework’. In: *Engineering Structures* 297 (Dec. 2023), p. 116936. DOI: 10.1016/j.engstruct.2023.116936. URL: <https://hal.science/hal-04039263> (cit. on pp. 19, 20).
- [69] T. A. Henzinger. ‘The Theory of Hybrid Automata’. In: *Verification of Digital and Hybrid Systems*. Springer Berlin Heidelberg, 1996, pp. 265–292. (Cit. on p. 7).
- [70] J.-B. Hiriart-Urruty and C. Lemaréchal. *Convex Analysis and Minimization Algorithms*. Vol. I and II. Springer Berlin Heidelberg, 1993. , (cit. on p. 7).
- [71] J.-B. Hiriart-Urruty and C. Lemaréchal. *Fundamentals of Convex Analysis*. Springer Berlin Heidelberg, 2001. , (cit. on pp. 5, 7).
- [72] O. Huber, B. Brogliato, V. Acary, A. Boubakir, F. Plestan and W. B. ‘Experimental results on implicit and explicit time-discretization of equivalent-control-based sliding-mode control’. In: *Recent Trends in Sliding Mode Control*. Ed. by L. Fridman, J. Barbot and F. Plestan. Institution of Engineering and Technology, 2016, pp. 207–235. , (cit. on p. 16).
- [73] O. Huber, V. Acary, B. Brogliato and F. Plestan. ‘Implicit discrete-time twisting controller without numerical chattering: analysis and experimental results’. In: *Control Engineering Practice* 46 (2016), pp. 129–141. , (cit. on p. 16).
- [74] G. James. ‘Periodic travelling waves and compactons in granular chains’. In: *Journal of Nonlinear Science* 22.5 (2012), pp. 813–848. , (cit. on p. 10).
- [75] G. James, P. G. Kevrekidis and J. Cuevas. ‘Breathers in oscillator chains with Hertzian interactions’. In: *Physica D: Nonlinear Phenomena* 251 (2013), pp. 39–59. , (cit. on p. 10).
- [76] M. Jean, V. Acary and Y. Monerie. ‘Non Smooth Contact dynamics approach of cohesive materials’. In: *Philosophical Transactions of the Royal Society of London. Series A: Mathematical, Physical and Engineering Sciences* 359.1789 (2001), pp. 2497–2518. , (cit. on p. 9).
- [77] M. Keiler, J. Knight and S. Harrison. ‘Climate change and geomorphological hazards in the eastern European Alps’. In: *Philosophical Transactions of the Royal Society A: Mathematical, Physical and Engineering Sciences* 368.1919 (2010), pp. 2461–2479. (Cit. on p. 3).
- [78] R. Leine and N. van de Wouw. *Stability and Convergence of Mechanical Systems with Unilateral Constraints*. Vol. 36. Lecture Notes in Applied and Computational Mechanics. Springer Verlag, 2008 (cit. on p. 3).

- [79] R. I. Leine, A. Schweizer, M. Christen, J. Glover, P. Bartelt and W. Gerber. ‘Simulation of rockfall trajectories with consideration of rock shape’. In: *Multibody System Dynamics* 32.2 (2014), pp. 241–271. , (cit. on p. 9).
- [80] L. Liu, G. James, P. Kevrekidis and A. Vainchtein. ‘Nonlinear waves in a strongly resonant granular chain’. In: *Nonlinearity* 29.11 (2016), pp. 3496–3527. , (cit. on p. 10).
- [81] F. A. Miranda-Villatoro, F. Forni and R. J. Sepulchre. ‘Dissipativity analysis of negative resistance circuits’. In: *Automatica* 136 (2022), p. 110011 (cit. on p. 13).
- [82] F. A. Miranda-Villatoro, B. Brogliato and F. Castanos. ‘Multivalued Robust Tracking Control of Lagrange Systems: Continuous and Discrete-Time Algorithms’. In: *IEEE Transactions on Automatic Control* 62.9 (2017), pp. 4436–4450. , (cit. on p. 16).
- [83] J. Morales, G. James and A. Tonnelier. *Solitary waves in the excitable Burridge-Knopoff model*. Research Report RR-8996. To appear in Wave Motion. INRIA Grenoble - Rhône-Alpes, 2016, pp. 103–121. , (cit. on p. 15).
- [84] Y. Nesterov. ‘A method of solving a convex programming problem with convergence rate $O(1/k^2)$ ’. In: *Soviet Mathematics Doklady* 27.2 (1983), pp. 372–376 (cit. on p. 12).
- [85] M. H. Nguyen. ‘Numerical optimization for rolling frictional contact problems’. MA thesis. Université de Limoges, Sept. 2021. URL: <https://hal.inria.fr/hal-03483150> (cit. on p. 21).
- [86] M.-H. Nguyen, V. Acary and P. Armand. ‘Second-order cone programming for rolling friction contact mechanics’. In: *SMAI MODE 2022*. 2022 (cit. on p. 21).
- [87] N. Nguyen and B. Brogliato. *Multiple Impacts in Dissipative Granular Chains*. Vol. 72. Lecture Notes in Applied and Computational Mechanics. XXII, 234 p. 109 illus. Springer Verlag, 2014 (cit. on p. 10).
- [88] M. A. Porter, P. G. Kevrekidis and C. Daraio. ‘Granular crystals: Nonlinear dynamics meets materials engineering’. In: *Physics Today* 68.11 (2015), pp. 44–50. , (cit. on p. 10).
- [89] A. Rist. ‘Hydrothermal processes within the active layer above alpine permafrost in steep scree slopes and their influence on slope stability’. PhD thesis. University of Zurich, 2007 (cit. on p. 3).
- [90] R. T. Rockafellar. *Convex Analysis*. Princeton University Press, 1970. (Cit. on p. 7).
- [91] T. Schindler and V. Acary. ‘Timestepping schemes for nonsmooth dynamics based on discontinuous Galerkin methods: Definition and outlook’. In: *Mathematics and Computers in Simulation* 95 (2013), pp. 180–199. , (cit. on p. 8).
- [92] T. Schindler, S. Rezaei, J. Kursawe and V. Acary. ‘Half-explicit timestepping schemes on velocity level based on time-discontinuous Galerkin methods’. In: *Computer Methods in Applied Mechanics and Engineering* 290.15 (2015), pp. 250–276. , (cit. on p. 8).
- [93] M. Shpakovych. ‘Numerical optimization for frictional contact problems’. MA thesis. Université de Limoges, Sept. 2019. URL: <https://hal.inria.fr/hal-03483159> (cit. on p. 21).
- [94] C. Studer. *Numerics of Unilateral Contacts and Friction. – Modeling and Numerical Time Integration in Non-Smooth Dynamics*. Vol. 47. Lecture Notes in Applied and Computational Mechanics. Springer Verlag, 2009 (cit. on p. 8).